

Test Report

No.: EDG2209210142C00101R

Date: Oct. 08, 2022

Page 1 of 94

Applicant : SHENZHEN LEADSHINE CONTROL TECHNOLOGY CO.,LTD

Address : 15/F, Block B, Nanshan I Valley, No.3157, Shahe West Road, Nanshan District, Shenzhen, China

Sample Name : LC5000 Intelligent controller

Style/Item No. : LC5128/LC5256/ LC5128P/LC5256P

Brand name :  雷赛智能
Leadshine

Received Date : Sep. 22, 2022

Test Period : Sep. 22, 2022 ~ Oct. 08, 2022

Test Requested : As requested by the client, to evaluate the compliance of the submitted sample with EU RoHS Directive 2011/65/EU Annex II and its amendment (EU) 2015/863 on the restriction of the use of certain hazardous substances in electrical and electronic equipment.

Test Method : 1. Review was performed for the sample and the related Bill of Materials submitted by the Applicant.
2. a) Refer to the standard IEC 62321-3-1:2013: Screening by XRF Spectroscopy.
b) Wet chemical test
1) Refer to IEC 62321-5:2013, determine the Cadmium, Lead content by ICP-OES.
2) Refer to IEC 62321-4:2013+A1:2017, determine the Mercury content by ICP-OES;
3) Refer to IEC 62321-7-1:2015 & IEC 62321-7-2:2017, determine the Hexavalent Chromium content by UV-VIS.
4) Refer to IEC 62321-6:2015, determine the Polybrominated Biphenyls and Polybrominated Diphenyl Ethers by GC-MS.
5) Refer to IEC 62321-8:2017, determine the Dibutyl phthalate(DBP), Benzylbutyl phthalate(BBP), Di-2-ethylhexyl phthalate(DEHP) and Diisobutyl phthalate(DIBP) by GC-MS.

Test Results : Please refer to next page (s).

Test results are only responsible for delivered samples. This test report is issued by the company and is intended for your exclusive use. This test report includes all of the testes requested by you and the results thereof based upon the information that you provided. You have 30 days from data of issuance of this test report to notify us of any error or omission caused by our negligence. A failure to raise such issue within the prescribed time shall constitute your unqualified acceptance of the completeness of this report, the tests conducted and the correctness of the report contents.



Test Report

No.: EDG2209210142C00101R

Date: Oct. 08, 2022

Page 2 of 94

Conclusion:

Basing on the test results obtained from the homogenous materials, the submitted sample **COMPLIES** with the EU RoHS Directive 2011/65/EU Annex II and its amendment (EU) 2015/863.



Signed for and on behalf of
EMTEK(Dongguan) Co., Ltd.

Prepared by:



Wu Jiali, Garli
Report Engineer

Reviewed by:



Li Jiaxin, Nell
Supervisor

Approved by:



Li Wei, Lisa
Authorized signatory
Oct. 08, 2022

Test results are only responsible for delivered samples. This test report is issued by the company and is intended for your exclusive use. This test report includes all of the testes requested by you and the results thereof based upon the information that you provided. You have 30 days from data of issuance of this test report to notify us of any error or omission caused by our negligence. A failure to raise such issue within the prescribed time shall constitute your unqualified acceptance of the completeness of this report, the tests conducted and the correctness of the report contents.



Test Report

No.: EDG2209210142C00101R

Date: Oct. 08, 2022

Page 3 of 94

Test Results:

1. Pb, Cd, Hg, Cr⁶⁺, PBBs, PBDEs Test Results:

No.	Sample description	Restricted substances	Analytical element	Results of EDXRF ⁽¹⁾	Results of Chemical Testing ⁽²⁾ (mg/kg)	Conclusion	Remark
1	Label	Pb	Pb	BL	NA	Pass	No comment
		Cd	Cd	BL			
		Hg	Hg	BL			
		Cr ⁶⁺	Cr	BL			
		PBBs	Br	BL			
		PBDEs					
2	Silver metal with black coating	Pb	Pb	BL	NA	Pass	No comment
		Cd	Cd	BL			
		Hg	Hg	BL			
		Cr ⁶⁺	Cr	BL			
		PBBs	Br	NA			
		PBDEs					
3	Silver metal	Pb	Pb	BL	NA	Pass	No comment
		Cd	Cd	BL			
		Hg	Hg	BL			
		Cr ⁶⁺	Cr	BL			
		PBBs	Br	NA			
		PBDEs					
4	Silver metal	Pb	Pb	BL	NA	Pass	No comment
		Cd	Cd	BL			
		Hg	Hg	BL			
		Cr ⁶⁺	Cr	BL			
		PBBs	Br	NA			
		PBDEs					
5	Copper metal	Pb	Pb	BL	NA	Pass	No comment
		Cd	Cd	BL			
		Hg	Hg	BL			
		Cr ⁶⁺	Cr	BL			
		PBBs	Br	NA			
		PBDEs					

Test results are only responsible for delivered samples. This test report is issued by the company and is intended for your exclusive use. This test report includes all of the testes requested by you and the results thereof based upon the information that you provided. You have 30 days from data of issuance of this test report to notify us of any error or omission caused by our negligence. A failure to raise such issue within the prescribed time shall constitute your unqualified acceptance of the completeness of this report, the tests conducted and the correctness of the report contents.



Test Report

No.: EDG2209210142C00101R

Date: Oct. 08, 2022

Page 4 of 94

No.	Sample description	Restricted substances	Analytical element	Results of EDXRF ⁽¹⁾	Results of Chemical Testing ⁽²⁾ (mg/kg)	Conclusion	Remark
6	Copper metal	Pb	Pb	BL	NA	Pass	No comment
		Cd	Cd	BL			
		Hg	Hg	BL			
		Cr ⁶⁺	Cr	BL			
		PBBs	Br	NA			
		PBDEs					
7	Silver metal	Pb	Pb	BL	NA	Pass	No comment
		Cd	Cd	BL			
		Hg	Hg	BL			
		Cr ⁶⁺	Cr	BL			
		PBBs	Br	NA			
		PBDEs					
8	Grey glue	Pb	Pb	BL	NA	Pass	No comment
		Cd	Cd	BL			
		Hg	Hg	BL			
		Cr ⁶⁺	Cr	BL			
		PBBs	Br	BL			
		PBDEs					
9	Silver metal	Pb	Pb	BL	Cr ⁶⁺ : Negative	Pass	No comment
		Cd	Cd	BL			
		Hg	Hg	BL			
		Cr ⁶⁺	Cr	X			
		PBBs	Br	NA			
		PBDEs					
10	Silver metal	Pb	Pb	BL	NA	Pass	No comment
		Cd	Cd	BL			
		Hg	Hg	BL			
		Cr ⁶⁺	Cr	BL			
		PBBs	Br	NA			
		PBDEs					

Test results are only responsible for delivered samples. This test report is issued by the company and is intended for your exclusive use. This test report includes all of the testes requested by you and the results thereof based upon the information that you provided. You have 30 days from data of issuance of this test report to notify us of any error or omission caused by our negligence. A failure to raise such issue within the prescribed time shall constitute your unqualified acceptance of the completeness of this report, the tests conducted and the correctness of the report contents.



Test Report

No.: EDG2209210142C00101R

Date: Oct. 08, 2022

Page 5 of 94

No.	Sample description	Restricted substances	Analytical element	Results of EDXRF ⁽¹⁾	Results of Chemical Testing ⁽²⁾ (mg/kg)	Conclusion	Remark
11	Silver metal	Pb	Pb	BL	NA	Pass	No comment
		Cd	Cd	BL			
		Hg	Hg	BL			
		Cr ⁶⁺	Cr	BL			
		PBBs	Br	NA			
		PBDEs					
12	White hard plastic	Pb	Pb	BL	NA	Pass	No comment
		Cd	Cd	BL			
		Hg	Hg	BL			
		Cr ⁶⁺	Cr	BL			
		PBBs	Br	BL			
		PBDEs					
13	Silver metal	Pb	Pb	BL	NA	Pass	No comment
		Cd	Cd	BL			
		Hg	Hg	BL			
		Cr ⁶⁺	Cr	BL			
		PBBs	Br	NA			
		PBDEs					
14	Red soft plastic	Pb	Pb	BL	NA	Pass	No comment
		Cd	Cd	BL			
		Hg	Hg	BL			
		Cr ⁶⁺	Cr	BL			
		PBBs	Br	BL			
		PBDEs					
15	Black soft plastic	Pb	Pb	BL	NA	Pass	No comment
		Cd	Cd	BL			
		Hg	Hg	BL			
		Cr ⁶⁺	Cr	BL			
		PBBs	Br	BL			
		PBDEs					

Test results are only responsible for delivered samples. This test report is issued by the company and is intended for your exclusive use. This test report includes all of the testes requested by you and the results thereof based upon the information that you provided. You have 30 days from data of issuance of this test report to notify us of any error or omission caused by our negligence. A failure to raise such issue within the prescribed time shall constitute your unqualified acceptance of the completeness of this report, the tests conducted and the correctness of the report contents.



Test Report

No.: EDG2209210142C00101R

Date: Oct. 08, 2022

Page 6 of 94

No.	Sample description	Restricted substances	Analytical element	Results of EDXRF ⁽¹⁾	Results of Chemical Testing ⁽²⁾ (mg/kg)	Conclusion	Remark
16	Silver metal	Pb	Pb	BL	NA	Pass	No comment
		Cd	Cd	BL			
		Hg	Hg	BL			
		Cr ⁶⁺	Cr	BL			
		PBBs	Br	NA			
		PBDEs					
17	Black soft plastic	Pb	Pb	BL	NA	Pass	No comment
		Cd	Cd	BL			
		Hg	Hg	BL			
		Cr ⁶⁺	Cr	BL			
		PBBs	Br	BL			
		PBDEs					
18	Yellow glue	Pb	Pb	BL	NA	Pass	No comment
		Cd	Cd	BL			
		Hg	Hg	BL			
		Cr ⁶⁺	Cr	BL			
		PBBs	Br	BL			
		PBDEs					
19	Label	Pb	Pb	BL	NA	Pass	No comment
		Cd	Cd	BL			
		Hg	Hg	BL			
		Cr ⁶⁺	Cr	BL			
		PBBs	Br	BL			
		PBDEs					
20	Black hard plastic	Pb	Pb	BL	NA	Pass	No comment
		Cd	Cd	BL			
		Hg	Hg	BL			
		Cr ⁶⁺	Cr	BL			
		PBBs	Br	X	ND		
		PBDEs			ND		

Test results are only responsible for delivered samples. This test report is issued by the company and is intended for your exclusive use. This test report includes all of the testes requested by you and the results thereof based upon the information that you provided. You have 30 days from data of issuance of this test report to notify us of any error or omission caused by our negligence. A failure to raise such issue within the prescribed time shall constitute your unqualified acceptance of the completeness of this report, the tests conducted and the correctness of the report contents.



Test Report

No.: EDG2209210142C00101R

Date: Oct. 08, 2022

Page 7 of 94

No.	Sample description	Restricted substances	Analytical element	Results of EDXRF ⁽¹⁾	Results of Chemical Testing ⁽²⁾ (mg/kg)	Conclusion	Remark
21	Black solid	Pb	Pb	BL	NA	Pass	No comment
		Cd	Cd	BL			
		Hg	Hg	BL			
		Cr ⁶⁺	Cr	BL			
		PBBs	Br	BL			
		PBDEs					
22	Silver metal	Pb	Pb	BL	NA	Pass	No comment
		Cd	Cd	BL			
		Hg	Hg	BL			
		Cr ⁶⁺	Cr	BL			
		PBBs	Br	NA			
		PBDEs					
23	Copper metal	Pb	Pb	BL	NA	Pass	No comment
		Cd	Cd	BL			
		Hg	Hg	BL			
		Cr ⁶⁺	Cr	BL			
		PBBs	Br	NA			
		PBDEs					
24	Silver metal	Pb	Pb	BL	NA	Pass	No comment
		Cd	Cd	BL			
		Hg	Hg	BL			
		Cr ⁶⁺	Cr	BL			
		PBBs	Br	NA			
		PBDEs					
25	Black hard plastic	Pb	Pb	BL	NA	Pass	No comment
		Cd	Cd	BL			
		Hg	Hg	BL			
		Cr ⁶⁺	Cr	BL			
		PBBs	Br	BL			
		PBDEs					

Test results are only responsible for delivered samples. This test report is issued by the company and is intended for your exclusive use. This test report includes all of the testes requested by you and the results thereof based upon the information that you provided. You have 30 days from data of issuance of this test report to notify us of any error or omission caused by our negligence. A failure to raise such issue within the prescribed time shall constitute your unqualified acceptance of the completeness of this report, the tests conducted and the correctness of the report contents.



Test Report

No.: EDG2209210142C00101R

Date: Oct. 08, 2022

Page 8 of 94

No.	Sample description	Restricted substances	Analytical element	Results of EDXRF ⁽¹⁾	Results of Chemical Testing ⁽²⁾ (mg/kg)	Conclusion	Remark
26	Green PCB	Pb	Pb	BL	NA	Pass	No comment
		Cd	Cd	BL			
		Hg	Hg	BL			
		Cr ⁶⁺	Cr	BL			
		PBBs	Br	BL			
		PBDEs					
27	Black solid	Pb	Pb	BL	NA	Pass	No comment
		Cd	Cd	BL			
		Hg	Hg	BL			
		Cr ⁶⁺	Cr	BL			
		PBBs	Br	BL			
		PBDEs					
28	SMD resister	Pb	Pb	BL	NA	Pass	No comment
		Cd	Cd	BL			
		Hg	Hg	BL			
		Cr ⁶⁺	Cr	BL			
		PBBs	Br	BL			
		PBDEs					
29	SMD capacitor	Pb	Pb	BL	NA	Pass	No comment
		Cd	Cd	BL			
		Hg	Hg	BL			
		Cr ⁶⁺	Cr	BL			
		PBBs	Br	BL			
		PBDEs					
30	Solder-silver metal	Pb	Pb	BL	NA	Pass	No comment
		Cd	Cd	BL			
		Hg	Hg	BL			
		Cr ⁶⁺	Cr	BL			
		PBBs	Br	NA			
		PBDEs					

Test results are only responsible for delivered samples. This test report is issued by the company and is intended for your exclusive use. This test report includes all of the testes requested by you and the results thereof based upon the information that you provided. You have 30 days from data of issuance of this test report to notify us of any error or omission caused by our negligence. A failure to raise such issue within the prescribed time shall constitute your unqualified acceptance of the completeness of this report, the tests conducted and the correctness of the report contents.



Test Report

No.: EDG2209210142C00101R

Date: Oct. 08, 2022

Page 9 of 94

No.	Sample description	Restricted substances	Analytical element	Results of EDXRF ⁽¹⁾	Results of Chemical Testing ⁽²⁾ (mg/kg)	Conclusion	Remark	
31	Green PCB	Pb	Pb	BL	NA	Pass	No comment	
		Cd	Cd	BL				
		Hg	Hg	BL				
		Cr ⁶⁺	Cr	BL				
		PBBs	Br	X	ND			
		PBDEs			ND			
32	Black solid	Pb	Pb	BL	NA	Pass	No comment	
		Cd	Cd	BL				
		Hg	Hg	BL				
		Cr ⁶⁺	Cr	BL				
		PBBs	Br	BL				
		PBDEs						
33	Silver metal with black printing	Pb	Pb	BL	NA	Pass	No comment	
		Cd	Cd	BL				
		Hg	Hg	BL				
		Cr ⁶⁺	Cr	BL				
		PBBs	Br	NA				
		PBDEs						
34	Black solid	Pb	Pb	BL	NA	Pass	No comment	
		Cd	Cd	BL				
		Hg	Hg	BL				
		Cr ⁶⁺	Cr	BL				
		PBBs	Br	BL				
		PBDEs						
35	Black soft plastic	Pb	Pb	BL	NA	Pass	No comment	
		Cd	Cd	BL				
		Hg	Hg	BL				
		Cr ⁶⁺	Cr	BL				
		PBBs	Br	BL				
		PBDEs						

Test results are only responsible for delivered samples. This test report is issued by the company and is intended for your exclusive use. This test report includes all of the testes requested by you and the results thereof based upon the information that you provided. You have 30 days from data of issuance of this test report to notify us of any error or omission caused by our negligence. A failure to raise such issue within the prescribed time shall constitute your unqualified acceptance of the completeness of this report, the tests conducted and the correctness of the report contents.



Test Report

No.: EDG2209210142C00101R

Date: Oct. 08, 2022

Page 10 of 94

No.	Sample description	Restricted substances	Analytical element	Results of EDXRF ⁽¹⁾	Results of Chemical Testing ⁽²⁾ (mg/kg)	Conclusion	Remark
36	Brown paper	Pb	Pb	BL	NA	Pass	No comment
		Cd	Cd	BL			
		Hg	Hg	BL			
		Cr ⁶⁺	Cr	BL			
		PBBs	Br	BL			
		PBDEs					
37	Dark silver metal	Pb	Pb	BL	NA	Pass	No comment
		Cd	Cd	BL			
		Hg	Hg	BL			
		Cr ⁶⁺	Cr	BL			
		PBBs	Br	NA			
		PBDEs					
38	Bright silver metal	Pb	Pb	BL	NA	Pass	No comment
		Cd	Cd	BL			
		Hg	Hg	BL			
		Cr ⁶⁺	Cr	BL			
		PBBs	Br	NA			
		PBDEs					
39	Pin-silver metal	Pb	Pb	BL	NA	Pass	No comment
		Cd	Cd	BL			
		Hg	Hg	BL			
		Cr ⁶⁺	Cr	BL			
		PBBs	Br	NA			
		PBDEs					
40	Black hard plastic	Pb	Pb	BL	NA	Pass	No comment
		Cd	Cd	BL			
		Hg	Hg	BL			
		Cr ⁶⁺	Cr	BL			
		PBBs	Br	BL			
		PBDEs					

Test results are only responsible for delivered samples. This test report is issued by the company and is intended for your exclusive use. This test report includes all of the testes requested by you and the results thereof based upon the information that you provided. You have 30 days from data of issuance of this test report to notify us of any error or omission caused by our negligence. A failure to raise such issue within the prescribed time shall constitute your unqualified acceptance of the completeness of this report, the tests conducted and the correctness of the report contents.



Test Report

No.: EDG2209210142C00101R

Date: Oct. 08, 2022

Page 11 of 94

No.	Sample description	Restricted substances	Analytical element	Results of EDXRF ⁽¹⁾	Results of Chemical Testing ⁽²⁾ (mg/kg)	Conclusion	Remark	
41	Grey solid	Pb	Pb	BL	NA	Pass	No comment	
		Cd	Cd	BL				
		Hg	Hg	BL				
		Cr ⁶⁺	Cr	BL				
		PBBs	Br	BL				
		PBDEs						
42	Green PCB	Pb	Pb	BL	NA	Pass	No comment	
		Cd	Cd	BL				
		Hg	Hg	BL				
		Cr ⁶⁺	Cr	BL				
		PBBs	Br	X				ND
		PBDEs						ND
43	Grey solid	Pb	Pb	BL	NA	Pass	No comment	
		Cd	Cd	BL				
		Hg	Hg	BL				
		Cr ⁶⁺	Cr	BL				
		PBBs	Br	BL				
		PBDEs						
44	SMD triode	Pb	Pb	OL	Pb:22645	Pass	See remark (3)	
		Cd	Cd	BL				
		Hg	Hg	BL				
		Cr ⁶⁺	Cr	BL				
		PBBs	Br	BL				
		PBDEs						
45	SMD resister	Pb	Pb	BL	NA	Pass	No comment	
		Cd	Cd	BL				
		Hg	Hg	BL				
		Cr ⁶⁺	Cr	BL				
		PBBs	Br	BL				
		PBDEs						

Test results are only responsible for delivered samples. This test report is issued by the company and is intended for your exclusive use. This test report includes all of the testes requested by you and the results thereof based upon the information that you provided. You have 30 days from data of issuance of this test report to notify us of any error or omission caused by our negligence. A failure to raise such issue within the prescribed time shall constitute your unqualified acceptance of the completeness of this report, the tests conducted and the correctness of the report contents.



Test Report

No.: EDG2209210142C00101R

Date: Oct. 08, 2022

Page 12 of 94

No.	Sample description	Restricted substances	Analytical element	Results of EDXRF ⁽¹⁾	Results of Chemical Testing ⁽²⁾ (mg/kg)	Conclusion	Remark
46	SMD resister	Pb	Pb	BL	NA	Pass	No comment
		Cd	Cd	BL			
		Hg	Hg	BL			
		Cr ⁶⁺	Cr	BL			
		PBBs	Br	BL			
		PBDEs					
47	Silver metal	Pb	Pb	BL	NA	Pass	No comment
		Cd	Cd	BL			
		Hg	Hg	BL			
		Cr ⁶⁺	Cr	BL			
		PBBs	Br	NA			
		PBDEs					
48	Dark grey solid	Pb	Pb	BL	NA	Pass	No comment
		Cd	Cd	BL			
		Hg	Hg	BL			
		Cr ⁶⁺	Cr	BL			
		PBBs	Br	BL			
		PBDEs					
49	Dark grey solid	Pb	Pb	BL	NA	Pass	No comment
		Cd	Cd	BL			
		Hg	Hg	BL			
		Cr ⁶⁺	Cr	BL			
		PBBs	Br	BL			
		PBDEs					
50	Copper enameled wire	Pb	Pb	BL	NA	Pass	No comment
		Cd	Cd	BL			
		Hg	Hg	BL			
		Cr ⁶⁺	Cr	BL			
		PBBs	Br	BL			
		PBDEs					

Test results are only responsible for delivered samples. This test report is issued by the company and is intended for your exclusive use. This test report includes all of the testes requested by you and the results thereof based upon the information that you provided. You have 30 days from data of issuance of this test report to notify us of any error or omission caused by our negligence. A failure to raise such issue within the prescribed time shall constitute your unqualified acceptance of the completeness of this report, the tests conducted and the correctness of the report contents.



Test Report

No.: EDG2209210142C00101R

Date: Oct. 08, 2022

Page 13 of 94

No.	Sample description	Restricted substances	Analytical element	Results of EDXRF ⁽¹⁾	Results of Chemical Testing ⁽²⁾ (mg/kg)	Conclusion	Remark
51	SMD IC	Pb	Pb	OL	Pb:29538	Pass	See remark (3)
		Cd	Cd	BL			
		Hg	Hg	BL			
		Cr ⁶⁺	Cr	BL			
		PBBs	Br	BL			
		PBDEs					
52	Pin-silver metal	Pb	Pb	BL	NA	Pass	No comment
		Cd	Cd	BL			
		Hg	Hg	BL			
		Cr ⁶⁺	Cr	BL			
		PBBs	Br	NA			
		PBDEs					
53	SMD diode	Pb	Pb	BL	NA	Pass	No comment
		Cd	Cd	BL			
		Hg	Hg	BL			
		Cr ⁶⁺	Cr	BL			
		PBBs	Br	BL			
		PBDEs					
54	Black solid	Pb	Pb	BL	NA	Pass	No comment
		Cd	Cd	BL			
		Hg	Hg	BL			
		Cr ⁶⁺	Cr	BL			
		PBBs	Br	BL			
		PBDEs					
55	SMD LED	Pb	Pb	BL	NA	Pass	No comment
		Cd	Cd	BL			
		Hg	Hg	BL			
		Cr ⁶⁺	Cr	BL			
		PBBs	Br	BL			
		PBDEs					

Test results are only responsible for delivered samples. This test report is issued by the company and is intended for your exclusive use. This test report includes all of the testes requested by you and the results thereof based upon the information that you provided. You have 30 days from data of issuance of this test report to notify us of any error or omission caused by our negligence. A failure to raise such issue within the prescribed time shall constitute your unqualified acceptance of the completeness of this report, the tests conducted and the correctness of the report contents.



Test Report

No.: EDG2209210142C00101R

Date: Oct. 08, 2022

Page 14 of 94

No.	Sample description	Restricted substances	Analytical element	Results of EDXRF ⁽¹⁾	Results of Chemical Testing ⁽²⁾ (mg/kg)	Conclusion	Remark	
56	Black hard plastic	Pb	Pb	BL	NA	Pass	No comment	
		Cd	Cd	BL				
		Hg	Hg	BL				
		Cr ⁶⁺	Cr	BL				
		PBBs	Br	X	ND			
		PBDEs			ND			
57	Silver metal	Pb	Pb	BL	NA	Pass	No comment	
		Cd	Cd	BL				
		Hg	Hg	BL				
		Cr ⁶⁺	Cr	BL				
		PBBs	Br	NA				
		PBDEs						
58	SMD diode	Pb	Pb	OL	Pb:29127	Pass	See remark (3)	
		Cd	Cd	BL				
		Hg	Hg	BL				
		Cr ⁶⁺	Cr	BL				
		PBBs	Br	BL				
		PBDEs						
59	SMD capacitor	Pb	Pb	BL	NA	Pass	No comment	
		Cd	Cd	BL				
		Hg	Hg	BL				
		Cr ⁶⁺	Cr	BL				
		PBBs	Br	BL				
		PBDEs						
60	SMD IC	Pb	Pb	BL	NA	Pass	No comment	
		Cd	Cd	BL				
		Hg	Hg	BL				
		Cr ⁶⁺	Cr	BL				
		PBBs	Br	BL				
		PBDEs						

Test results are only responsible for delivered samples. This test report is issued by the company and is intended for your exclusive use. This test report includes all of the testes requested by you and the results thereof based upon the information that you provided. You have 30 days from data of issuance of this test report to notify us of any error or omission caused by our negligence. A failure to raise such issue within the prescribed time shall constitute your unqualified acceptance of the completeness of this report, the tests conducted and the correctness of the report contents.



Test Report

No.: EDG2209210142C00101R

Date: Oct. 08, 2022

Page 15 of 94

No.	Sample description	Restricted substances	Analytical element	Results of EDXRF ⁽¹⁾	Results of Chemical Testing ⁽²⁾ (mg/kg)	Conclusion	Remark
61	SMD diode	Pb	Pb	OL	Pb:33852	Pass	See remark (3)
		Cd	Cd	BL			
		Hg	Hg	BL			
		Cr ⁶⁺	Cr	BL			
		PBBs	Br	BL			
		PBDEs					
62	Black hard plastic	Pb	Pb	BL	NA	Pass	No comment
		Cd	Cd	BL			
		Hg	Hg	BL			
		Cr ⁶⁺	Cr	BL			
		PBBs	Br	BL			
		PBDEs					
63	Grey solid	Pb	Pb	BL	NA	Pass	No comment
		Cd	Cd	BL			
		Hg	Hg	BL			
		Cr ⁶⁺	Cr	BL			
		PBBs	Br	BL			
		PBDEs					
64	Green PCB	Pb	Pb	BL	NA	Pass	No comment
		Cd	Cd	BL			
		Hg	Hg	BL			
		Cr ⁶⁺	Cr	BL			
		PBBs	Br	BL			
		PBDEs					
65	SMD capacitor	Pb	Pb	BL	NA	Pass	No comment
		Cd	Cd	BL			
		Hg	Hg	BL			
		Cr ⁶⁺	Cr	BL			
		PBBs	Br	BL			
		PBDEs					

Test results are only responsible for delivered samples. This test report is issued by the company and is intended for your exclusive use. This test report includes all of the testes requested by you and the results thereof based upon the information that you provided. You have 30 days from data of issuance of this test report to notify us of any error or omission caused by our negligence. A failure to raise such issue within the prescribed time shall constitute your unqualified acceptance of the completeness of this report, the tests conducted and the correctness of the report contents.



Test Report

No.: EDG2209210142C00101R

Date: Oct. 08, 2022

Page 16 of 94

No.	Sample description	Restricted substances	Analytical element	Results of EDXRF ⁽¹⁾	Results of Chemical Testing ⁽²⁾ (mg/kg)	Conclusion	Remark
66	SMD IC	Pb	Pb	BL	NA	Pass	No comment
		Cd	Cd	BL			
		Hg	Hg	BL			
		Cr ⁶⁺	Cr	BL			
		PBBs	Br	BL			
		PBDEs					
67	SMD inductor	Pb	Pb	BL	NA	Pass	No comment
		Cd	Cd	BL			
		Hg	Hg	BL			
		Cr ⁶⁺	Cr	BL			
		PBBs	Br	BL			
		PBDEs					
68	SMD IC	Pb	Pb	BL	NA	Pass	No comment
		Cd	Cd	BL			
		Hg	Hg	BL			
		Cr ⁶⁺	Cr	BL			
		PBBs	Br	BL			
		PBDEs					
69	SMD capacitor	Pb	Pb	BL	NA	Pass	No comment
		Cd	Cd	BL			
		Hg	Hg	BL			
		Cr ⁶⁺	Cr	BL			
		PBBs	Br	BL			
		PBDEs					
70	SMD IC	Pb	Pb	BL	NA	Pass	No comment
		Cd	Cd	BL			
		Hg	Hg	BL			
		Cr ⁶⁺	Cr	BL			
		PBBs	Br	BL			
		PBDEs					

Test results are only responsible for delivered samples. This test report is issued by the company and is intended for your exclusive use. This test report includes all of the testes requested by you and the results thereof based upon the information that you provided. You have 30 days from data of issuance of this test report to notify us of any error or omission caused by our negligence. A failure to raise such issue within the prescribed time shall constitute your unqualified acceptance of the completeness of this report, the tests conducted and the correctness of the report contents.



Test Report

No.: EDG2209210142C00101R

Date: Oct. 08, 2022

Page 17 of 94

No.	Sample description	Restricted substances	Analytical element	Results of EDXRF ⁽¹⁾	Results of Chemical Testing ⁽²⁾ (mg/kg)	Conclusion	Remark
71	Blue soft plastic with white printing	Pb	Pb	BL	NA	Pass	No comment
		Cd	Cd	BL			
		Hg	Hg	BL			
		Cr ⁶⁺	Cr	BL			
		PBBs	Br	BL			
		PBDEs					
72	Black soft plastic	Pb	Pb	BL	NA	Pass	No comment
		Cd	Cd	BL			
		Hg	Hg	BL			
		Cr ⁶⁺	Cr	BL			
		PBBs	Br	BL			
		PBDEs					
73	Silver metal	Pb	Pb	BL	NA	Pass	No comment
		Cd	Cd	BL			
		Hg	Hg	BL			
		Cr ⁶⁺	Cr	BL			
		PBBs	Br	NA			
		PBDEs					
74	Brown paper	Pb	Pb	BL	NA	Pass	No comment
		Cd	Cd	BL			
		Hg	Hg	BL			
		Cr ⁶⁺	Cr	BL			
		PBBs	Br	BL			
		PBDEs					
75	Bright silver metal	Pb	Pb	BL	NA	Pass	No comment
		Cd	Cd	BL			
		Hg	Hg	BL			
		Cr ⁶⁺	Cr	BL			
		PBBs	Br	NA			
		PBDEs					

Test results are only responsible for delivered samples. This test report is issued by the company and is intended for your exclusive use. This test report includes all of the testes requested by you and the results thereof based upon the information that you provided. You have 30 days from data of issuance of this test report to notify us of any error or omission caused by our negligence. A failure to raise such issue within the prescribed time shall constitute your unqualified acceptance of the completeness of this report, the tests conducted and the correctness of the report contents.



Test Report

No.: EDG2209210142C00101R

Date: Oct. 08, 2022

Page 18 of 94

No.	Sample description	Restricted substances	Analytical element	Results of EDXRF ⁽¹⁾	Results of Chemical Testing ⁽²⁾ (mg/kg)	Conclusion	Remark
76	Dark silver metal	Pb	Pb	BL	NA	Pass	No comment
		Cd	Cd	BL			
		Hg	Hg	BL			
		Cr ⁶⁺	Cr	BL			
		PBBs	Br	NA			
		PBDEs					
77	Transparent glue tape	Pb	Pb	BL	NA	Pass	No comment
		Cd	Cd	BL			
		Hg	Hg	BL			
		Cr ⁶⁺	Cr	BL			
		PBBs	Br	BL			
		PBDEs					
78	Pin-silver metal	Pb	Pb	BL	NA	Pass	No comment
		Cd	Cd	BL			
		Hg	Hg	BL			
		Cr ⁶⁺	Cr	BL			
		PBBs	Br	NA			
		PBDEs					
79	SMD IC	Pb	Pb	BL	NA	Pass	No comment
		Cd	Cd	BL			
		Hg	Hg	BL			
		Cr ⁶⁺	Cr	BL			
		PBBs	Br	BL			
		PBDEs					
80	SMD diode	Pb	Pb	OL	Pb:28008	Pass	See remark (3)
		Cd	Cd	BL			
		Hg	Hg	BL			
		Cr ⁶⁺	Cr	BL			
		PBBs	Br	BL			
		PBDEs					

Test results are only responsible for delivered samples. This test report is issued by the company and is intended for your exclusive use. This test report includes all of the testes requested by you and the results thereof based upon the information that you provided. You have 30 days from data of issuance of this test report to notify us of any error or omission caused by our negligence. A failure to raise such issue within the prescribed time shall constitute your unqualified acceptance of the completeness of this report, the tests conducted and the correctness of the report contents.



Test Report

No.: EDG2209210142C00101R

Date: Oct. 08, 2022

Page 19 of 94

No.	Sample description	Restricted substances	Analytical element	Results of EDXRF ⁽¹⁾	Results of Chemical Testing ⁽²⁾ (mg/kg)	Conclusion	Remark
81	Grey solid	Pb	Pb	BL	NA	Pass	No comment
		Cd	Cd	BL			
		Hg	Hg	BL			
		Cr ⁶⁺	Cr	BL			
		PBBs	Br	BL			
		PBDEs					
82	SMD inductor	Pb	Pb	BL	NA	Pass	No comment
		Cd	Cd	BL			
		Hg	Hg	BL			
		Cr ⁶⁺	Cr	BL			
		PBBs	Br	BL			
		PBDEs					
83	Black solid	Pb	Pb	BL	NA	Pass	No comment
		Cd	Cd	BL			
		Hg	Hg	BL			
		Cr ⁶⁺	Cr	BL			
		PBBs	Br	BL			
		PBDEs					
84	Yellow solid	Pb	Pb	BL	NA	Pass	No comment
		Cd	Cd	BL			
		Hg	Hg	BL			
		Cr ⁶⁺	Cr	BL			
		PBBs	Br	BL			
		PBDEs					
85	Black hard plastic	Pb	Pb	BL	NA	Pass	No comment
		Cd	Cd	BL			
		Hg	Hg	BL			
		Cr ⁶⁺	Cr	BL			
		PBBs	Br	X	ND		
		PBDEs			ND		

Test results are only responsible for delivered samples. This test report is issued by the company and is intended for your exclusive use. This test report includes all of the testes requested by you and the results thereof based upon the information that you provided. You have 30 days from data of issuance of this test report to notify us of any error or omission caused by our negligence. A failure to raise such issue within the prescribed time shall constitute your unqualified acceptance of the completeness of this report, the tests conducted and the correctness of the report contents.



Test Report

No.: EDG2209210142C00101R

Date: Oct. 08, 2022

Page 20 of 94

No.	Sample description	Restricted substances	Analytical element	Results of EDXRF ⁽¹⁾	Results of Chemical Testing ⁽²⁾ (mg/kg)	Conclusion	Remark
86	Silver metal	Pb	Pb	BL	NA	Pass	No comment
		Cd	Cd	BL			
		Hg	Hg	BL			
		Cr ⁶⁺	Cr	BL			
		PBBs	Br	NA			
		PBDEs					
87	SMD diode	Pb	Pb	BL	NA	Pass	No comment
		Cd	Cd	BL			
		Hg	Hg	BL			
		Cr ⁶⁺	Cr	BL			
		PBBs	Br	BL			
		PBDEs					
88	Dark grey solid	Pb	Pb	BL	NA	Pass	No comment
		Cd	Cd	BL			
		Hg	Hg	BL			
		Cr ⁶⁺	Cr	BL			
		PBBs	Br	BL			
		PBDEs					
89	Copper metal	Pb	Pb	BL	NA	Pass	No comment
		Cd	Cd	BL			
		Hg	Hg	BL			
		Cr ⁶⁺	Cr	BL			
		PBBs	Br	NA			
		PBDEs					
90	SMD diode	Pb	Pb	OL	Pb:28337	Pass	See remark (3)
		Cd	Cd	BL			
		Hg	Hg	BL			
		Cr ⁶⁺	Cr	BL			
		PBBs	Br	BL			
		PBDEs					

Test results are only responsible for delivered samples. This test report is issued by the company and is intended for your exclusive use. This test report includes all of the testes requested by you and the results thereof based upon the information that you provided. You have 30 days from data of issuance of this test report to notify us of any error or omission caused by our negligence. A failure to raise such issue within the prescribed time shall constitute your unqualified acceptance of the completeness of this report, the tests conducted and the correctness of the report contents.



Test Report

No.: EDG2209210142C00101R

Date: Oct. 08, 2022

Page 21 of 94

No.	Sample description	Restricted substances	Analytical element	Results of EDXRF ⁽¹⁾	Results of Chemical Testing ⁽²⁾ (mg/kg)	Conclusion	Remark
91	Black solid	Pb	Pb	BL	NA	Pass	No comment
		Cd	Cd	BL			
		Hg	Hg	BL			
		Cr ⁶⁺	Cr	BL			
		PBBs	Br	BL			
		PBDEs					
92	Black solid	Pb	Pb	BL	NA	Pass	No comment
		Cd	Cd	BL			
		Hg	Hg	BL			
		Cr ⁶⁺	Cr	BL			
		PBBs	Br	BL			
		PBDEs					
93	SMD resister	Pb	Pb	BL	NA	Pass	No comment
		Cd	Cd	BL			
		Hg	Hg	BL			
		Cr ⁶⁺	Cr	BL			
		PBBs	Br	BL			
		PBDEs					
94	Solder-silver metal	Pb	Pb	BL	NA	Pass	No comment
		Cd	Cd	BL			
		Hg	Hg	BL			
		Cr ⁶⁺	Cr	BL			
		PBBs	Br	NA			
		PBDEs					
95	Yellow solid	Pb	Pb	BL	NA	Pass	No comment
		Cd	Cd	BL			
		Hg	Hg	BL			
		Cr ⁶⁺	Cr	BL			
		PBBs	Br	BL			
		PBDEs					

Test results are only responsible for delivered samples. This test report is issued by the company and is intended for your exclusive use. This test report includes all of the testes requested by you and the results thereof based upon the information that you provided. You have 30 days from data of issuance of this test report to notify us of any error or omission caused by our negligence. A failure to raise such issue within the prescribed time shall constitute your unqualified acceptance of the completeness of this report, the tests conducted and the correctness of the report contents.



Test Report

No.: EDG2209210142C00101R

Date: Oct. 08, 2022

Page 22 of 94

No.	Sample description	Restricted substances	Analytical element	Results of EDXRF ⁽¹⁾	Results of Chemical Testing ⁽²⁾ (mg/kg)	Conclusion	Remark	
96	Pin-silver metal	Pb	Pb	BL	NA	Pass	No comment	
		Cd	Cd	BL				
		Hg	Hg	BL				
		Cr ⁶⁺	Cr	BL				
		PBBs	Br	NA				
		PBDEs						
97	Green PCB	Pb	Pb	BL	NA	Pass	No comment	
		Cd	Cd	BL				
		Hg	Hg	BL				
		Cr ⁶⁺	Cr	BL				
		PBBs	Br	X				ND
		PBDEs						ND
98	Grey solid	Pb	Pb	BL	NA	Pass	No comment	
		Cd	Cd	BL				
		Hg	Hg	BL				
		Cr ⁶⁺	Cr	BL				
		PBBs	Br	BL				
		PBDEs						
99	Silver metal	Pb	Pb	OL	Pb:30684	Pass	See remark (3)	
		Cd	Cd	BL				
		Hg	Hg	BL				
		Cr ⁶⁺	Cr	BL				
		PBBs	Br	NA				
		PBDEs						
100	Dark grey solid	Pb	Pb	BL	NA	Pass	No comment	
		Cd	Cd	BL				
		Hg	Hg	BL				
		Cr ⁶⁺	Cr	BL				
		PBBs	Br	BL				
		PBDEs						

Test results are only responsible for delivered samples. This test report is issued by the company and is intended for your exclusive use. This test report includes all of the testes requested by you and the results thereof based upon the information that you provided. You have 30 days from data of issuance of this test report to notify us of any error or omission caused by our negligence. A failure to raise such issue within the prescribed time shall constitute your unqualified acceptance of the completeness of this report, the tests conducted and the correctness of the report contents.



Test Report

No.: EDG2209210142C00101R

Date: Oct. 08, 2022

Page 23 of 94

No.	Sample description	Restricted substances	Analytical element	Results of EDXRF ⁽¹⁾	Results of Chemical Testing ⁽²⁾ (mg/kg)	Conclusion	Remark
101	SMD resister	Pb	Pb	BL	NA	Pass	No comment
		Cd	Cd	BL			
		Hg	Hg	BL			
		Cr ⁶⁺	Cr	BL			
		PBBs	Br	BL			
		PBDEs					
102	SMD triode	Pb	Pb	BL	NA	Pass	No comment
		Cd	Cd	BL			
		Hg	Hg	BL			
		Cr ⁶⁺	Cr	BL			
		PBBs	Br	BL			
		PBDEs					
103	Black hard plastic	Pb	Pb	BL	NA	Pass	No comment
		Cd	Cd	BL			
		Hg	Hg	BL			
		Cr ⁶⁺	Cr	BL			
		PBBs	Br	X	ND		
		PBDEs			ND		
104	Pin-silver metal	Pb	Pb	BL	NA	Pass	No comment
		Cd	Cd	BL			
		Hg	Hg	BL			
		Cr ⁶⁺	Cr	BL			
		PBBs	Br	NA			
		PBDEs					
105	SMD capacitor	Pb	Pb	BL	NA	Pass	No comment
		Cd	Cd	BL			
		Hg	Hg	BL			
		Cr ⁶⁺	Cr	BL			
		PBBs	Br	BL			
		PBDEs					

Test results are only responsible for delivered samples. This test report is issued by the company and is intended for your exclusive use. This test report includes all of the testes requested by you and the results thereof based upon the information that you provided. You have 30 days from data of issuance of this test report to notify us of any error or omission caused by our negligence. A failure to raise such issue within the prescribed time shall constitute your unqualified acceptance of the completeness of this report, the tests conducted and the correctness of the report contents.



Test Report

No.: EDG2209210142C00101R

Date: Oct. 08, 2022

Page 24 of 94

No.	Sample description	Restricted substances	Analytical element	Results of EDXRF ⁽¹⁾	Results of Chemical Testing ⁽²⁾ (mg/kg)	Conclusion	Remark
106	SMD diode	Pb	Pb	BL	NA	Pass	No comment
		Cd	Cd	BL			
		Hg	Hg	BL			
		Cr ⁶⁺	Cr	BL			
		PBBs	Br	BL			
		PBDEs					
107	Silver metal with blue printing	Pb	Pb	BL	NA	Pass	No comment
		Cd	Cd	BL			
		Hg	Hg	BL			
		Cr ⁶⁺	Cr	BL			
		PBBs	Br	NA			
		PBDEs					
108	Black soft plastic	Pb	Pb	BL	NA	Pass	No comment
		Cd	Cd	BL			
		Hg	Hg	BL			
		Cr ⁶⁺	Cr	BL			
		PBBs	Br	BL			
		PBDEs					
109	Brown paper	Pb	Pb	BL	NA	Pass	No comment
		Cd	Cd	BL			
		Hg	Hg	BL			
		Cr ⁶⁺	Cr	BL			
		PBBs	Br	BL			
		PBDEs					
110	Bright silver metal	Pb	Pb	BL	NA	Pass	No comment
		Cd	Cd	BL			
		Hg	Hg	BL			
		Cr ⁶⁺	Cr	BL			
		PBBs	Br	NA			
		PBDEs					

Test results are only responsible for delivered samples. This test report is issued by the company and is intended for your exclusive use. This test report includes all of the testes requested by you and the results thereof based upon the information that you provided. You have 30 days from data of issuance of this test report to notify us of any error or omission caused by our negligence. A failure to raise such issue within the prescribed time shall constitute your unqualified acceptance of the completeness of this report, the tests conducted and the correctness of the report contents.



Test Report

No.: EDG2209210142C00101R

Date: Oct. 08, 2022

Page 25 of 94

No.	Sample description	Restricted substances	Analytical element	Results of EDXRF ⁽¹⁾	Results of Chemical Testing ⁽²⁾ (mg/kg)	Conclusion	Remark
111	Dark silver metal	Pb	Pb	BL	NA	Pass	No comment
		Cd	Cd	BL			
		Hg	Hg	BL			
		Cr ⁶⁺	Cr	BL			
		PBBs	Br	NA			
		PBDEs					
112	Pin-silver metal	Pb	Pb	BL	NA	Pass	No comment
		Cd	Cd	BL			
		Hg	Hg	BL			
		Cr ⁶⁺	Cr	BL			
		PBBs	Br	NA			
		PBDEs					
113	SMD IC	Pb	Pb	BL	NA	Pass	No comment
		Cd	Cd	BL			
		Hg	Hg	BL			
		Cr ⁶⁺	Cr	BL			
		PBBs	Br	BL			
		PBDEs					
114	SMD IC	Pb	Pb	BL	NA	Pass	No comment
		Cd	Cd	BL			
		Hg	Hg	BL			
		Cr ⁶⁺	Cr	BL			
		PBBs	Br	BL			
		PBDEs					
115	SMD IC	Pb	Pb	BL	NA	Pass	No comment
		Cd	Cd	BL			
		Hg	Hg	BL			
		Cr ⁶⁺	Cr	BL			
		PBBs	Br	BL			
		PBDEs					

Test results are only responsible for delivered samples. This test report is issued by the company and is intended for your exclusive use. This test report includes all of the testes requested by you and the results thereof based upon the information that you provided. You have 30 days from data of issuance of this test report to notify us of any error or omission caused by our negligence. A failure to raise such issue within the prescribed time shall constitute your unqualified acceptance of the completeness of this report, the tests conducted and the correctness of the report contents.



Test Report

No.: EDG2209210142C00101R

Date: Oct. 08, 2022

Page 26 of 94

No.	Sample description	Restricted substances	Analytical element	Results of EDXRF ⁽¹⁾	Results of Chemical Testing ⁽²⁾ (mg/kg)	Conclusion	Remark
116	Silver metal	Pb	Pb	BL	NA	Pass	No comment
		Cd	Cd	BL			
		Hg	Hg	BL			
		Cr ⁶⁺	Cr	BL			
		PBBs	Br	NA			
		PBDEs					
117	Dark grey solid	Pb	Pb	BL	NA	Pass	No comment
		Cd	Cd	BL			
		Hg	Hg	BL			
		Cr ⁶⁺	Cr	BL			
		PBBs	Br	BL			
		PBDEs					
118	Silver metal	Pb	Pb	BL	NA	Pass	No comment
		Cd	Cd	BL			
		Hg	Hg	BL			
		Cr ⁶⁺	Cr	BL			
		PBBs	Br	NA			
		PBDEs					
119	Solder-silver metal	Pb	Pb	BL	NA	Pass	No comment
		Cd	Cd	BL			
		Hg	Hg	BL			
		Cr ⁶⁺	Cr	BL			
		PBBs	Br	NA			
		PBDEs					
120	Black solid	Pb	Pb	BL	NA	Pass	No comment
		Cd	Cd	BL			
		Hg	Hg	BL			
		Cr ⁶⁺	Cr	BL			
		PBBs	Br	BL			
		PBDEs					

Test results are only responsible for delivered samples. This test report is issued by the company and is intended for your exclusive use. This test report includes all of the testes requested by you and the results thereof based upon the information that you provided. You have 30 days from data of issuance of this test report to notify us of any error or omission caused by our negligence. A failure to raise such issue within the prescribed time shall constitute your unqualified acceptance of the completeness of this report, the tests conducted and the correctness of the report contents.



Test Report

No.: EDG2209210142C00101R

Date: Oct. 08, 2022

Page 27 of 94

No.	Sample description	Restricted substances	Analytical element	Results of EDXRF ⁽¹⁾	Results of Chemical Testing ⁽²⁾ (mg/kg)	Conclusion	Remark
121	Silver metal with purple printing	Pb	Pb	BL	NA	Pass	No comment
		Cd	Cd	BL			
		Hg	Hg	BL			
		Cr ⁶⁺	Cr	BL			
		PBBs	Br	NA			
		PBDEs					
122	SMD inductor	Pb	Pb	BL	NA	Pass	No comment
		Cd	Cd	BL			
		Hg	Hg	BL			
		Cr ⁶⁺	Cr	BL			
		PBBs	Br	BL			
		PBDEs					
123	Black hard plastic	Pb	Pb	BL	NA	Pass	No comment
		Cd	Cd	BL			
		Hg	Hg	BL			
		Cr ⁶⁺	Cr	BL			
		PBBs	Br	X			
		PBDEs					
124	SMD inductor	Pb	Pb	BL	NA	Pass	No comment
		Cd	Cd	BL			
		Hg	Hg	BL			
		Cr ⁶⁺	Cr	BL			
		PBBs	Br	BL			
		PBDEs					
125	Silver metal	Pb	Pb	BL	NA	Pass	No comment
		Cd	Cd	BL			
		Hg	Hg	BL			
		Cr ⁶⁺	Cr	BL			
		PBBs	Br	NA			
		PBDEs					

Test results are only responsible for delivered samples. This test report is issued by the company and is intended for your exclusive use. This test report includes all of the testes requested by you and the results thereof based upon the information that you provided. You have 30 days from data of issuance of this test report to notify us of any error or omission caused by our negligence. A failure to raise such issue within the prescribed time shall constitute your unqualified acceptance of the completeness of this report, the tests conducted and the correctness of the report contents.



Test Report

No.: EDG2209210142C00101R

Date: Oct. 08, 2022

Page 28 of 94

No.	Sample description	Restricted substances	Analytical element	Results of EDXRF ⁽¹⁾	Results of Chemical Testing ⁽²⁾ (mg/kg)	Conclusion	Remark
126	Green hard plastic	Pb	Pb	BL	NA	Pass	No comment
		Cd	Cd	BL			
		Hg	Hg	BL			
		Cr ⁶⁺	Cr	BL			
		PBBs	Br	BL			
		PBDEs					
127	Silver metal	Pb	Pb	BL	NA	Pass	No comment
		Cd	Cd	BL			
		Hg	Hg	BL			
		Cr ⁶⁺	Cr	BL			
		PBBs	Br	NA			
		PBDEs					
128	Blue solid	Pb	Pb	BL	NA	Pass	No comment
		Cd	Cd	BL			
		Hg	Hg	BL			
		Cr ⁶⁺	Cr	BL			
		PBBs	Br	BL			
		PBDEs					
129	Black solid	Pb	Pb	OL	Pb:29717	Pass	See remark (3)
		Cd	Cd	BL			
		Hg	Hg	BL			
		Cr ⁶⁺	Cr	BL			
		PBBs	Br	BL			
		PBDEs					
130	Black soft plastic with grey printing	Pb	Pb	BL	NA	Pass	No comment
		Cd	Cd	BL			
		Hg	Hg	BL			
		Cr ⁶⁺	Cr	BL			
		PBBs	Br	BL			
		PBDEs					

Test results are only responsible for delivered samples. This test report is issued by the company and is intended for your exclusive use. This test report includes all of the testes requested by you and the results thereof based upon the information that you provided. You have 30 days from data of issuance of this test report to notify us of any error or omission caused by our negligence. A failure to raise such issue within the prescribed time shall constitute your unqualified acceptance of the completeness of this report, the tests conducted and the correctness of the report contents.



Test Report

No.: EDG2209210142C00101R

Date: Oct. 08, 2022

Page 29 of 94

No.	Sample description	Restricted substances	Analytical element	Results of EDXRF ⁽¹⁾	Results of Chemical Testing ⁽²⁾ (mg/kg)	Conclusion	Remark
131	Black soft plastic	Pb	Pb	BL	NA	Pass	No comment
		Cd	Cd	BL			
		Hg	Hg	BL			
		Cr ⁶⁺	Cr	BL			
		PBBs	Br	BL			
		PBDEs					
132	Silver metal	Pb	Pb	BL	NA	Pass	No comment
		Cd	Cd	BL			
		Hg	Hg	BL			
		Cr ⁶⁺	Cr	BL			
		PBBs	Br	NA			
		PBDEs					
133	Brown paper	Pb	Pb	BL	NA	Pass	No comment
		Cd	Cd	BL			
		Hg	Hg	BL			
		Cr ⁶⁺	Cr	BL			
		PBBs	Br	BL			
		PBDEs					
134	Bright silver metal	Pb	Pb	BL	NA	Pass	No comment
		Cd	Cd	BL			
		Hg	Hg	BL			
		Cr ⁶⁺	Cr	BL			
		PBBs	Br	NA			
		PBDEs					
135	Dark silver metal	Pb	Pb	BL	NA	Pass	No comment
		Cd	Cd	BL			
		Hg	Hg	BL			
		Cr ⁶⁺	Cr	BL			
		PBBs	Br	NA			
		PBDEs					

Test results are only responsible for delivered samples. This test report is issued by the company and is intended for your exclusive use. This test report includes all of the testes requested by you and the results thereof based upon the information that you provided. You have 30 days from data of issuance of this test report to notify us of any error or omission caused by our negligence. A failure to raise such issue within the prescribed time shall constitute your unqualified acceptance of the completeness of this report, the tests conducted and the correctness of the report contents.



Test Report

No.: EDG2209210142C00101R

Date: Oct. 08, 2022

Page 30 of 94

No.	Sample description	Restricted substances	Analytical element	Results of EDXRF ⁽¹⁾	Results of Chemical Testing ⁽²⁾ (mg/kg)	Conclusion	Remark
136	Pin-silver metal	Pb	Pb	BL	NA	Pass	No comment
		Cd	Cd	BL			
		Hg	Hg	BL			
		Cr ⁶⁺	Cr	BL			
		PBBs	Br	NA			
		PBDEs					
137	SMD capacitor	Pb	Pb	BL	NA	Pass	No comment
		Cd	Cd	BL			
		Hg	Hg	BL			
		Cr ⁶⁺	Cr	BL			
		PBBs	Br	BL			
		PBDEs					
138	SMD IC	Pb	Pb	BL	NA	Pass	No comment
		Cd	Cd	BL			
		Hg	Hg	BL			
		Cr ⁶⁺	Cr	BL			
		PBBs	Br	BL			
		PBDEs					
139	SMD resister	Pb	Pb	BL	NA	Pass	No comment
		Cd	Cd	BL			
		Hg	Hg	BL			
		Cr ⁶⁺	Cr	BL			
		PBBs	Br	BL			
		PBDEs					
140	SMD diode	Pb	Pb	OL	Pb:27302	Pass	See remark (3)
		Cd	Cd	BL			
		Hg	Hg	BL			
		Cr ⁶⁺	Cr	BL			
		PBBs	Br	BL			
		PBDEs					

Test results are only responsible for delivered samples. This test report is issued by the company and is intended for your exclusive use. This test report includes all of the testes requested by you and the results thereof based upon the information that you provided. You have 30 days from data of issuance of this test report to notify us of any error or omission caused by our negligence. A failure to raise such issue within the prescribed time shall constitute your unqualified acceptance of the completeness of this report, the tests conducted and the correctness of the report contents.



Test Report

No.: EDG2209210142C00101R

Date: Oct. 08, 2022

Page 31 of 94

No.	Sample description	Restricted substances	Analytical element	Results of EDXRF ⁽¹⁾	Results of Chemical Testing ⁽²⁾ (mg/kg)	Conclusion	Remark
141	SMD resister	Pb	Pb	BL	NA	Pass	No comment
		Cd	Cd	BL			
		Hg	Hg	BL			
		Cr ⁶⁺	Cr	BL			
		PBBs	Br	BL			
		PBDEs					
142	Yellow solid	Pb	Pb	BL	NA	Pass	No comment
		Cd	Cd	BL			
		Hg	Hg	BL			
		Cr ⁶⁺	Cr	BL			
		PBBs	Br	BL			
		PBDEs					
143	White ceramic	Pb	Pb	BL	NA	Pass	No comment
		Cd	Cd	BL			
		Hg	Hg	BL			
		Cr ⁶⁺	Cr	BL			
		PBBs	Br	BL			
		PBDEs					
144	Copper metal	Pb	Pb	BL	NA	Pass	No comment
		Cd	Cd	BL			
		Hg	Hg	BL			
		Cr ⁶⁺	Cr	BL			
		PBBs	Br	NA			
		PBDEs					
145	Solder with copper metal	Pb	Pb	BL	NA	Pass	No comment
		Cd	Cd	BL			
		Hg	Hg	BL			
		Cr ⁶⁺	Cr	BL			
		PBBs	Br	NA			
		PBDEs					

Test results are only responsible for delivered samples. This test report is issued by the company and is intended for your exclusive use. This test report includes all of the testes requested by you and the results thereof based upon the information that you provided. You have 30 days from data of issuance of this test report to notify us of any error or omission caused by our negligence. A failure to raise such issue within the prescribed time shall constitute your unqualified acceptance of the completeness of this report, the tests conducted and the correctness of the report contents.



Test Report

No.: EDG2209210142C00101R

Date: Oct. 08, 2022

Page 32 of 94

No.	Sample description	Restricted substances	Analytical element	Results of EDXRF ⁽¹⁾	Results of Chemical Testing ⁽²⁾ (mg/kg)	Conclusion	Remark
146	SMD diode	Pb	Pb	OL	Pb:25408	Pass	See remark (3)
		Cd	Cd	BL			
		Hg	Hg	BL			
		Cr ⁶⁺	Cr	BL			
		PBBs	Br	BL			
		PBDEs					
147	SMD IC	Pb	Pb	BL	NA	Pass	No comment
		Cd	Cd	BL			
		Hg	Hg	BL			
		Cr ⁶⁺	Cr	BL			
		PBBs	Br	BL			
		PBDEs					
148	Silver fabric	Pb	Pb	BL	NA	Pass	No comment
		Cd	Cd	BL			
		Hg	Hg	BL			
		Cr ⁶⁺	Cr	BL			
		PBBs	Br	BL			
		PBDEs					
149	Black foam	Pb	Pb	BL	NA	Pass	No comment
		Cd	Cd	BL			
		Hg	Hg	BL			
		Cr ⁶⁺	Cr	BL			
		PBBs	Br	BL			
		PBDEs					
150	Silver metal	Pb	Pb	BL	NA	Pass	No comment
		Cd	Cd	BL			
		Hg	Hg	BL			
		Cr ⁶⁺	Cr	BL			
		PBBs	Br	NA			
		PBDEs					

Test results are only responsible for delivered samples. This test report is issued by the company and is intended for your exclusive use. This test report includes all of the testes requested by you and the results thereof based upon the information that you provided. You have 30 days from data of issuance of this test report to notify us of any error or omission caused by our negligence. A failure to raise such issue within the prescribed time shall constitute your unqualified acceptance of the completeness of this report, the tests conducted and the correctness of the report contents.



Test Report

No.: EDG2209210142C00101R

Date: Oct. 08, 2022

Page 33 of 94

No.	Sample description	Restricted substances	Analytical element	Results of EDXRF ⁽¹⁾	Results of Chemical Testing ⁽²⁾ (mg/kg)	Conclusion	Remark
151	Dark grey hard plastic	Pb	Pb	BL	NA	Pass	No comment
		Cd	Cd	BL			
		Hg	Hg	BL			
		Cr ⁶⁺	Cr	BL			
		PBBs	Br	BL			
		PBDEs					
152	Black hard plastic	Pb	Pb	BL	NA	Pass	No comment
		Cd	Cd	BL			
		Hg	Hg	BL			
		Cr ⁶⁺	Cr	BL			
		PBBs	Br	BL			
		PBDEs					
153	Translucent hard plastic with silver coating	Pb	Pb	BL	NA	Pass	No comment
		Cd	Cd	BL			
		Hg	Hg	BL			
		Cr ⁶⁺	Cr	BL			
		PBBs	Br	BL			
		PBDEs					
154	Silver metal	Pb	Pb	BL	NA	Pass	No comment
		Cd	Cd	BL			
		Hg	Hg	BL			
		Cr ⁶⁺	Cr	BL			
		PBBs	Br	NA			
		PBDEs					
155	Black hard plastic	Pb	Pb	BL	NA	Pass	No comment
		Cd	Cd	BL			
		Hg	Hg	BL			
		Cr ⁶⁺	Cr	BL			
		PBBs	Br	BL			
		PBDEs					

Test results are only responsible for delivered samples. This test report is issued by the company and is intended for your exclusive use. This test report includes all of the testes requested by you and the results thereof based upon the information that you provided. You have 30 days from data of issuance of this test report to notify us of any error or omission caused by our negligence. A failure to raise such issue within the prescribed time shall constitute your unqualified acceptance of the completeness of this report, the tests conducted and the correctness of the report contents.



Test Report

No.: EDG2209210142C00101R

Date: Oct. 08, 2022

Page 34 of 94

No.	Sample description	Restricted substances	Analytical element	Results of EDXRF ⁽¹⁾	Results of Chemical Testing ⁽²⁾ (mg/kg)	Conclusion	Remark	
156	Green transparent hard plastic	Pb	Pb	BL	NA	Pass	No comment	
		Cd	Cd	BL				
		Hg	Hg	BL				
		Cr ⁶⁺	Cr	BL				
		PBBs	Br	BL				
		PBDEs						
157	Red transparent hard plastic	Pb	Pb	BL	NA	Pass	No comment	
		Cd	Cd	BL				
		Hg	Hg	BL				
		Cr ⁶⁺	Cr	BL				
		PBBs	Br	BL				
		PBDEs						
158	Silver metal	Pb	Pb	BL	NA	Pass	No comment	
		Cd	Cd	BL				
		Hg	Hg	BL				
		Cr ⁶⁺	Cr	BL				
		PBBs	Br	NA				
		PBDEs						
159	Black hard plastic	Pb	Pb	BL	NA	Pass	No comment	
		Cd	Cd	BL				
		Hg	Hg	BL				
		Cr ⁶⁺	Cr	BL				
		PBBs	Br	X				ND
		PBDEs						ND
160	Pin-silver metal	Pb	Pb	BL	NA	Pass	No comment	
		Cd	Cd	BL				
		Hg	Hg	BL				
		Cr ⁶⁺	Cr	BL				
		PBBs	Br	NA				
		PBDEs						

Test results are only responsible for delivered samples. This test report is issued by the company and is intended for your exclusive use. This test report includes all of the testes requested by you and the results thereof based upon the information that you provided. You have 30 days from data of issuance of this test report to notify us of any error or omission caused by our negligence. A failure to raise such issue within the prescribed time shall constitute your unqualified acceptance of the completeness of this report, the tests conducted and the correctness of the report contents.



Test Report

No.: EDG2209210142C00101R

Date: Oct. 08, 2022

Page 35 of 94

No.	Sample description	Restricted substances	Analytical element	Results of EDXRF ⁽¹⁾	Results of Chemical Testing ⁽²⁾ (mg/kg)	Conclusion	Remark	
161	Silver metal	Pb	Pb	BL	NA	Pass	No comment	
		Cd	Cd	BL				
		Hg	Hg	BL				
		Cr ⁶⁺	Cr	BL				
		PBBs	Br	NA				
		PBDEs						
162	Black hard plastic	Pb	Pb	BL	NA	Pass	No comment	
		Cd	Cd	BL				
		Hg	Hg	BL				
		Cr ⁶⁺	Cr	BL				
		PBBs	Br	X				ND
		PBDEs						ND
163	Silver metal	Pb	Pb	BL	NA	Pass	No comment	
		Cd	Cd	BL				
		Hg	Hg	BL				
		Cr ⁶⁺	Cr	BL				
		PBBs	Br	NA				
		PBDEs						
164	Label	Pb	Pb	BL	NA	Pass	No comment	
		Cd	Cd	BL				
		Hg	Hg	BL				
		Cr ⁶⁺	Cr	BL				
		PBBs	Br	BL				
		PBDEs						
165	Silver metal	Pb	Pb	BL	NA	Pass	No comment	
		Cd	Cd	BL				
		Hg	Hg	BL				
		Cr ⁶⁺	Cr	BL				
		PBBs	Br	NA				
		PBDEs						

Test results are only responsible for delivered samples. This test report is issued by the company and is intended for your exclusive use. This test report includes all of the testes requested by you and the results thereof based upon the information that you provided. You have 30 days from data of issuance of this test report to notify us of any error or omission caused by our negligence. A failure to raise such issue within the prescribed time shall constitute your unqualified acceptance of the completeness of this report, the tests conducted and the correctness of the report contents.



Test Report

No.: EDG2209210142C00101R

Date: Oct. 08, 2022

Page 36 of 94

No.	Sample description	Restricted substances	Analytical element	Results of EDXRF ⁽¹⁾	Results of Chemical Testing ⁽²⁾ (mg/kg)	Conclusion	Remark	
166	Black hard plastic	Pb	Pb	BL	NA	Pass	No comment	
		Cd	Cd	BL				
		Hg	Hg	BL				
		Cr ⁶⁺	Cr	BL				
		PBBs	Br	X	ND			
		PBDEs			ND			
167	Silver metal	Pb	Pb	BL	NA	Pass	No comment	
		Cd	Cd	BL				
		Hg	Hg	BL				
		Cr ⁶⁺	Cr	BL				
		PBBs	Br	NA				NA
		PBDEs						
168	Black hard plastic	Pb	Pb	BL	NA	Pass	No comment	
		Cd	Cd	BL				
		Hg	Hg	BL				
		Cr ⁶⁺	Cr	BL				
		PBBs	Br	BL				BL
		PBDEs						
169	Pin-silver metal	Pb	Pb	BL	NA	Pass	No comment	
		Cd	Cd	BL				
		Hg	Hg	BL				
		Cr ⁶⁺	Cr	BL				
		PBBs	Br	NA				NA
		PBDEs						
170	Copper metal	Pb	Pb	OL	Pb:27270	Pass	See remark (3)	
		Cd	Cd	BL				
		Hg	Hg	BL				
		Cr ⁶⁺	Cr	BL				
		PBBs	Br	NA				NA
		PBDEs						

Test results are only responsible for delivered samples. This test report is issued by the company and is intended for your exclusive use. This test report includes all of the testes requested by you and the results thereof based upon the information that you provided. You have 30 days from data of issuance of this test report to notify us of any error or omission caused by our negligence. A failure to raise such issue within the prescribed time shall constitute your unqualified acceptance of the completeness of this report, the tests conducted and the correctness of the report contents.



Test Report

No.: EDG2209210142C00101R

Date: Oct. 08, 2022

Page 37 of 94

No.	Sample description	Restricted substances	Analytical element	Results of EDXRF ⁽¹⁾	Results of Chemical Testing ⁽²⁾ (mg/kg)	Conclusion	Remark	
171	Black hard plastic	Pb	Pb	BL	NA	Pass	No comment	
		Cd	Cd	BL				
		Hg	Hg	BL				
		Cr ⁶⁺	Cr	BL				
		PBBs	Br	X	ND			
		PBDEs			ND			
172	Silver metal	Pb	Pb	BL	NA	Pass	No comment	
		Cd	Cd	BL				
		Hg	Hg	BL				
		Cr ⁶⁺	Cr	BL				
		PBBs	Br	NA				NA
		PBDEs						
173	Copper metal	Pb	Pb	BL	NA	Pass	No comment	
		Cd	Cd	BL				
		Hg	Hg	BL				
		Cr ⁶⁺	Cr	BL				
		PBBs	Br	NA				NA
		PBDEs						
174	Green PCB	Pb	Pb	BL	NA	Pass	No comment	
		Cd	Cd	BL				
		Hg	Hg	BL				
		Cr ⁶⁺	Cr	BL				
		PBBs	Br	BL				BL
		PBDEs						
175	Black hard plastic	Pb	Pb	BL	NA	Pass	No comment	
		Cd	Cd	BL				
		Hg	Hg	BL				
		Cr ⁶⁺	Cr	BL				
		PBBs	Br	BL				BL
		PBDEs						

Test results are only responsible for delivered samples. This test report is issued by the company and is intended for your exclusive use. This test report includes all of the testes requested by you and the results thereof based upon the information that you provided. You have 30 days from data of issuance of this test report to notify us of any error or omission caused by our negligence. A failure to raise such issue within the prescribed time shall constitute your unqualified acceptance of the completeness of this report, the tests conducted and the correctness of the report contents.



Test Report

No.: EDG2209210142C00101R

Date: Oct. 08, 2022

Page 38 of 94

No.	Sample description	Restricted substances	Analytical element	Results of EDXRF ⁽¹⁾	Results of Chemical Testing ⁽²⁾ (mg/kg)	Conclusion	Remark
176	Silver metal	Pb	Pb	BL	NA	Pass	No comment
		Cd	Cd	BL			
		Hg	Hg	BL			
		Cr ⁶⁺	Cr	BL			
		PBBs	Br	NA			
		PBDEs					
177	Black hard plastic	Pb	Pb	BL	NA	Pass	No comment
		Cd	Cd	BL			
		Hg	Hg	BL			
		Cr ⁶⁺	Cr	BL			
		PBBs	Br	BL			
		PBDEs					
178	SMD capacitor	Pb	Pb	BL	NA	Pass	No comment
		Cd	Cd	BL			
		Hg	Hg	BL			
		Cr ⁶⁺	Cr	BL			
		PBBs	Br	BL			
		PBDEs					
179	Silver metal	Pb	Pb	BL	NA	Pass	No comment
		Cd	Cd	BL			
		Hg	Hg	BL			
		Cr ⁶⁺	Cr	BL			
		PBBs	Br	NA			
		PBDEs					
180	Blue hard plastic	Pb	Pb	BL	NA	Pass	No comment
		Cd	Cd	BL			
		Hg	Hg	BL			
		Cr ⁶⁺	Cr	BL			
		PBBs	Br	BL			
		PBDEs					

Test results are only responsible for delivered samples. This test report is issued by the company and is intended for your exclusive use. This test report includes all of the testes requested by you and the results thereof based upon the information that you provided. You have 30 days from data of issuance of this test report to notify us of any error or omission caused by our negligence. A failure to raise such issue within the prescribed time shall constitute your unqualified acceptance of the completeness of this report, the tests conducted and the correctness of the report contents.



Test Report

No.: EDG2209210142C00101R

Date: Oct. 08, 2022

Page 39 of 94

No.	Sample description	Restricted substances	Analytical element	Results of EDXRF ⁽¹⁾	Results of Chemical Testing ⁽²⁾ (mg/kg)	Conclusion	Remark	
181	Silver metal	Pb	Pb	BL	NA	Pass	No comment	
		Cd	Cd	BL				
		Hg	Hg	BL				
		Cr ⁶⁺	Cr	BL				
		PBBs	Br	NA				
		PBDEs						
182	Beige hard plastic	Pb	Pb	BL	NA	Pass	No comment	
		Cd	Cd	BL				
		Hg	Hg	BL				
		Cr ⁶⁺	Cr	BL				
		PBBs	Br	X				ND
		PBDEs						ND
183	Pin-silver metal	Pb	Pb	BL	NA	Pass	No comment	
		Cd	Cd	BL				
		Hg	Hg	BL				
		Cr ⁶⁺	Cr	BL				
		PBBs	Br	NA				
		PBDEs						
184	Black solid	Pb	Pb	BL	NA	Pass	No comment	
		Cd	Cd	BL				
		Hg	Hg	BL				
		Cr ⁶⁺	Cr	BL				
		PBBs	Br	BL				
		PBDEs						
185	Pin-silver metal	Pb	Pb	BL	NA	Pass	No comment	
		Cd	Cd	BL				
		Hg	Hg	BL				
		Cr ⁶⁺	Cr	BL				
		PBBs	Br	NA				
		PBDEs						

Test results are only responsible for delivered samples. This test report is issued by the company and is intended for your exclusive use. This test report includes all of the testes requested by you and the results thereof based upon the information that you provided. You have 30 days from data of issuance of this test report to notify us of any error or omission caused by our negligence. A failure to raise such issue within the prescribed time shall constitute your unqualified acceptance of the completeness of this report, the tests conducted and the correctness of the report contents.



Test Report

No.: EDG2209210142C00101R

Date: Oct. 08, 2022

Page 40 of 94

No.	Sample description	Restricted substances	Analytical element	Results of EDXRF ⁽¹⁾	Results of Chemical Testing ⁽²⁾ (mg/kg)	Conclusion	Remark
186	SMD IC	Pb	Pb	BL	NA	Pass	No comment
		Cd	Cd	BL			
		Hg	Hg	BL			
		Cr ⁶⁺	Cr	BL			
		PBBs	Br	BL			
		PBDEs					
187	Silver metal	Pb	Pb	BL	NA	Pass	No comment
		Cd	Cd	BL			
		Hg	Hg	BL			
		Cr ⁶⁺	Cr	BL			
		PBBs	Br	NA			
		PBDEs					
188	SMD IC	Pb	Pb	BL	NA	Pass	No comment
		Cd	Cd	BL			
		Hg	Hg	BL			
		Cr ⁶⁺	Cr	BL			
		PBBs	Br	BL			
		PBDEs					
189	Silver metal	Pb	Pb	BL	NA	Pass	No comment
		Cd	Cd	BL			
		Hg	Hg	BL			
		Cr ⁶⁺	Cr	BL			
		PBBs	Br	NA			
		PBDEs					
190	Grey hard plastic	Pb	Pb	BL	NA	Pass	No comment
		Cd	Cd	BL			
		Hg	Hg	BL			
		Cr ⁶⁺	Cr	BL			
		PBBs	Br	BL			
		PBDEs					

Test results are only responsible for delivered samples. This test report is issued by the company and is intended for your exclusive use. This test report includes all of the testes requested by you and the results thereof based upon the information that you provided. You have 30 days from data of issuance of this test report to notify us of any error or omission caused by our negligence. A failure to raise such issue within the prescribed time shall constitute your unqualified acceptance of the completeness of this report, the tests conducted and the correctness of the report contents.



Test Report

No.: EDG2209210142C00101R

Date: Oct. 08, 2022

Page 41 of 94

No.	Sample description	Restricted substances	Analytical element	Results of EDXRF ⁽¹⁾	Results of Chemical Testing ⁽²⁾ (mg/kg)	Conclusion	Remark	
191	Silver metal	Pb	Pb	BL	NA	Pass	No comment	
		Cd	Cd	BL				
		Hg	Hg	BL				
		Cr ⁶⁺	Cr	BL				
		PBBs	Br	NA				
		PBDEs						
192	Black hard plastic	Pb	Pb	BL	NA	Pass	No comment	
		Cd	Cd	BL				
		Hg	Hg	BL				
		Cr ⁶⁺	Cr	BL				
		PBBs	Br	BL				
		PBDEs						
193	Copper metal	Pb	Pb	BL	NA	Pass	No comment	
		Cd	Cd	BL				
		Hg	Hg	BL				
		Cr ⁶⁺	Cr	BL				
		PBBs	Br	NA				
		PBDEs						
194	Black hard plastic	Pb	Pb	BL	NA	Pass	No comment	
		Cd	Cd	BL				
		Hg	Hg	BL				
		Cr ⁶⁺	Cr	BL				
		PBBs	Br	X				ND
		PBDEs						ND
195	Silver metal	Pb	Pb	BL	NA	Pass	No comment	
		Cd	Cd	BL				
		Hg	Hg	BL				
		Cr ⁶⁺	Cr	BL				
		PBBs	Br	NA				
		PBDEs						

Test results are only responsible for delivered samples. This test report is issued by the company and is intended for your exclusive use. This test report includes all of the testes requested by you and the results thereof based upon the information that you provided. You have 30 days from data of issuance of this test report to notify us of any error or omission caused by our negligence. A failure to raise such issue within the prescribed time shall constitute your unqualified acceptance of the completeness of this report, the tests conducted and the correctness of the report contents.



Test Report

No.: EDG2209210142C00101R

Date: Oct. 08, 2022

Page 42 of 94

No.	Sample description	Restricted substances	Analytical element	Results of EDXRF ⁽¹⁾	Results of Chemical Testing ⁽²⁾ (mg/kg)	Conclusion	Remark	
196	SMD IC	Pb	Pb	BL	NA	Pass	No comment	
		Cd	Cd	BL				
		Hg	Hg	BL				
		Cr ⁶⁺	Cr	BL				
		PBBs	Br	BL				
		PBDEs						
197	SMD IC	Pb	Pb	BL	NA	Pass	No comment	
		Cd	Cd	BL				
		Hg	Hg	BL				
		Cr ⁶⁺	Cr	BL				
		PBBs	Br	BL				
		PBDEs						
198	SMD resister	Pb	Pb	BL	NA	Pass	No comment	
		Cd	Cd	BL				
		Hg	Hg	BL				
		Cr ⁶⁺	Cr	BL				
		PBBs	Br	BL				
		PBDEs						
199	Green PCB	Pb	Pb	BL	NA	Pass	No comment	
		Cd	Cd	BL				
		Hg	Hg	BL				
		Cr ⁶⁺	Cr	BL				
		PBBs	Br	X				ND
		PBDEs						ND
200	Brown solid	Pb	Pb	BL	NA	Pass	No comment	
		Cd	Cd	BL				
		Hg	Hg	BL				
		Cr ⁶⁺	Cr	BL				
		PBBs	Br	BL				
		PBDEs						

Test results are only responsible for delivered samples. This test report is issued by the company and is intended for your exclusive use. This test report includes all of the testes requested by you and the results thereof based upon the information that you provided. You have 30 days from data of issuance of this test report to notify us of any error or omission caused by our negligence. A failure to raise such issue within the prescribed time shall constitute your unqualified acceptance of the completeness of this report, the tests conducted and the correctness of the report contents.



Test Report

No.: EDG2209210142C00101R

Date: Oct. 08, 2022

Page 43 of 94

No.	Sample description	Restricted substances	Analytical element	Results of EDXRF ⁽¹⁾	Results of Chemical Testing ⁽²⁾ (mg/kg)	Conclusion	Remark
201	Black solid	Pb	Pb	BL	NA	Pass	No comment
		Cd	Cd	BL			
		Hg	Hg	BL			
		Cr ⁶⁺	Cr	BL			
		PBBs	Br	BL			
		PBDEs					
202	SMD capacitor	Pb	Pb	BL	NA	Pass	No comment
		Cd	Cd	BL			
		Hg	Hg	BL			
		Cr ⁶⁺	Cr	BL			
		PBBs	Br	BL			
		PBDEs					
203	SMD IC	Pb	Pb	BL	NA	Pass	No comment
		Cd	Cd	BL			
		Hg	Hg	BL			
		Cr ⁶⁺	Cr	BL			
		PBBs	Br	BL			
		PBDEs					
204	Grey solid	Pb	Pb	BL	NA	Pass	No comment
		Cd	Cd	BL			
		Hg	Hg	BL			
		Cr ⁶⁺	Cr	BL			
		PBBs	Br	BL			
		PBDEs					
205	Beige hard plastic	Pb	Pb	BL	NA	Pass	No comment
		Cd	Cd	BL			
		Hg	Hg	BL			
		Cr ⁶⁺	Cr	BL			
		PBBs	Br	X	ND		
		PBDEs			ND		

Test results are only responsible for delivered samples. This test report is issued by the company and is intended for your exclusive use. This test report includes all of the testes requested by you and the results thereof based upon the information that you provided. You have 30 days from data of issuance of this test report to notify us of any error or omission caused by our negligence. A failure to raise such issue within the prescribed time shall constitute your unqualified acceptance of the completeness of this report, the tests conducted and the correctness of the report contents.



Test Report

No.: EDG2209210142C00101R

Date: Oct. 08, 2022

Page 44 of 94

No.	Sample description	Restricted substances	Analytical element	Results of EDXRF ⁽¹⁾	Results of Chemical Testing ⁽²⁾ (mg/kg)	Conclusion	Remark
206	Pin-silver metal	Pb	Pb	BL	NA	Pass	No comment
		Cd	Cd	BL			
		Hg	Hg	BL			
		Cr ⁶⁺	Cr	BL			
		PBBs	Br	NA			
		PBDEs					
207	SMD resister	Pb	Pb	BL	NA	Pass	No comment
		Cd	Cd	BL			
		Hg	Hg	BL			
		Cr ⁶⁺	Cr	BL			
		PBBs	Br	BL			
		PBDEs					
208	Black solid	Pb	Pb	BL	NA	Pass	No comment
		Cd	Cd	BL			
		Hg	Hg	BL			
		Cr ⁶⁺	Cr	BL			
		PBBs	Br	BL			
		PBDEs					
209	Black solid	Pb	Pb	BL	NA	Pass	No comment
		Cd	Cd	BL			
		Hg	Hg	BL			
		Cr ⁶⁺	Cr	BL			
		PBBs	Br	BL			
		PBDEs					
210	Dark grey hard plastic	Pb	Pb	BL	NA	Pass	No comment
		Cd	Cd	BL			
		Hg	Hg	BL			
		Cr ⁶⁺	Cr	BL			
		PBBs	Br	BL			
		PBDEs					

Test results are only responsible for delivered samples. This test report is issued by the company and is intended for your exclusive use. This test report includes all of the testes requested by you and the results thereof based upon the information that you provided. You have 30 days from data of issuance of this test report to notify us of any error or omission caused by our negligence. A failure to raise such issue within the prescribed time shall constitute your unqualified acceptance of the completeness of this report, the tests conducted and the correctness of the report contents.



Test Report

No.: EDG2209210142C00101R

Date: Oct. 08, 2022

Page 45 of 94

No.	Sample description	Restricted substances	Analytical element	Results of EDXRF ⁽¹⁾	Results of Chemical Testing ⁽²⁾ (mg/kg)	Conclusion	Remark
211	Silver metal	Pb	Pb	BL	NA	Pass	No comment
		Cd	Cd	BL			
		Hg	Hg	BL			
		Cr ⁶⁺	Cr	BL			
		PBBs	Br	NA			
		PBDEs					
212	Copper metal	Pb	Pb	BL	NA	Pass	No comment
		Cd	Cd	BL			
		Hg	Hg	BL			
		Cr ⁶⁺	Cr	BL			
		PBBs	Br	NA			
		PBDEs					
213	SMD resister	Pb	Pb	BL	NA	Pass	No comment
		Cd	Cd	BL			
		Hg	Hg	BL			
		Cr ⁶⁺	Cr	BL			
		PBBs	Br	BL			
		PBDEs					
214	SMD IC	Pb	Pb	BL	NA	Pass	No comment
		Cd	Cd	BL			
		Hg	Hg	BL			
		Cr ⁶⁺	Cr	BL			
		PBBs	Br	BL			
		PBDEs					
215	Pin-silver metal	Pb	Pb	BL	NA	Pass	No comment
		Cd	Cd	BL			
		Hg	Hg	BL			
		Cr ⁶⁺	Cr	BL			
		PBBs	Br	NA			
		PBDEs					

Test results are only responsible for delivered samples. This test report is issued by the company and is intended for your exclusive use. This test report includes all of the testes requested by you and the results thereof based upon the information that you provided. You have 30 days from data of issuance of this test report to notify us of any error or omission caused by our negligence. A failure to raise such issue within the prescribed time shall constitute your unqualified acceptance of the completeness of this report, the tests conducted and the correctness of the report contents.



Test Report

No.: EDG2209210142C00101R

Date: Oct. 08, 2022

Page 46 of 94

No.	Sample description	Restricted substances	Analytical element	Results of EDXRF ⁽¹⁾	Results of Chemical Testing ⁽²⁾ (mg/kg)	Conclusion	Remark
216	Label	Pb	Pb	BL	NA	Pass	No comment
		Cd	Cd	BL			
		Hg	Hg	BL			
		Cr ⁶⁺	Cr	BL			
		PBBs	Br	BL			
		PBDEs					
217	Dark grey hard plastic	Pb	Pb	BL	NA	Pass	No comment
		Cd	Cd	BL			
		Hg	Hg	BL			
		Cr ⁶⁺	Cr	BL			
		PBBs	Br	BL			
		PBDEs					
218	Silver metal	Pb	Pb	BL	NA	Pass	No comment
		Cd	Cd	BL			
		Hg	Hg	BL			
		Cr ⁶⁺	Cr	BL			
		PBBs	Br	NA			
		PBDEs					
219	Black solid	Pb	Pb	BL	NA	Pass	No comment
		Cd	Cd	BL			
		Hg	Hg	BL			
		Cr ⁶⁺	Cr	BL			
		PBBs	Br	BL			
		PBDEs					
220	Black solid	Pb	Pb	BL	NA	Pass	No comment
		Cd	Cd	BL			
		Hg	Hg	BL			
		Cr ⁶⁺	Cr	BL			
		PBBs	Br	BL			
		PBDEs					

Test results are only responsible for delivered samples. This test report is issued by the company and is intended for your exclusive use. This test report includes all of the testes requested by you and the results thereof based upon the information that you provided. You have 30 days from data of issuance of this test report to notify us of any error or omission caused by our negligence. A failure to raise such issue within the prescribed time shall constitute your unqualified acceptance of the completeness of this report, the tests conducted and the correctness of the report contents.



Test Report

No.: EDG2209210142C00101R

Date: Oct. 08, 2022

Page 47 of 94

No.	Sample description	Restricted substances	Analytical element	Results of EDXRF ⁽¹⁾	Results of Chemical Testing ⁽²⁾ (mg/kg)	Conclusion	Remark
221	Black hard plastic	Pb	Pb	BL	NA	Pass	No comment
		Cd	Cd	BL			
		Hg	Hg	BL			
		Cr ⁶⁺	Cr	BL			
		PBBs	Br	BL			
		PBDEs					
222	Green PCB	Pb	Pb	BL	NA	Pass	No comment
		Cd	Cd	BL			
		Hg	Hg	BL			
		Cr ⁶⁺	Cr	BL			
		PBBs	Br	BL			
		PBDEs					
223	SMD IC	Pb	Pb	BL	NA	Pass	No comment
		Cd	Cd	BL			
		Hg	Hg	BL			
		Cr ⁶⁺	Cr	BL			
		PBBs	Br	BL			
		PBDEs					
224	Pin-silver metal	Pb	Pb	BL	NA	Pass	No comment
		Cd	Cd	BL			
		Hg	Hg	BL			
		Cr ⁶⁺	Cr	BL			
		PBBs	Br	NA			
		PBDEs					
225	SMD triode	Pb	Pb	BL	NA	Pass	No comment
		Cd	Cd	BL			
		Hg	Hg	BL			
		Cr ⁶⁺	Cr	BL			
		PBBs	Br	BL			
		PBDEs					

Test results are only responsible for delivered samples. This test report is issued by the company and is intended for your exclusive use. This test report includes all of the testes requested by you and the results thereof based upon the information that you provided. You have 30 days from data of issuance of this test report to notify us of any error or omission caused by our negligence. A failure to raise such issue within the prescribed time shall constitute your unqualified acceptance of the completeness of this report, the tests conducted and the correctness of the report contents.



Test Report

No.: EDG2209210142C00101R

Date: Oct. 08, 2022

Page 48 of 94

No.	Sample description	Restricted substances	Analytical element	Results of EDXRF ⁽¹⁾	Results of Chemical Testing ⁽²⁾ (mg/kg)	Conclusion	Remark
226	SMD diode	Pb	Pb	BL	NA	Pass	No comment
		Cd	Cd	BL			
		Hg	Hg	BL			
		Cr ⁶⁺	Cr	BL			
		PBBs	Br	BL			
		PBDEs					
227	Label	Pb	Pb	BL	NA	Pass	No comment
		Cd	Cd	BL			
		Hg	Hg	BL			
		Cr ⁶⁺	Cr	BL			
		PBBs	Br	BL			
		PBDEs					
228	Brown solid	Pb	Pb	BL	NA	Pass	No comment
		Cd	Cd	BL			
		Hg	Hg	BL			
		Cr ⁶⁺	Cr	BL			
		PBBs	Br	BL			
		PBDEs					
229	Silver metal	Pb	Pb	BL	NA	Pass	No comment
		Cd	Cd	BL			
		Hg	Hg	BL			
		Cr ⁶⁺	Cr	BL			
		PBBs	Br	NA			
		PBDEs					
230	Grey solid	Pb	Pb	BL	NA	Pass	No comment
		Cd	Cd	BL			
		Hg	Hg	BL			
		Cr ⁶⁺	Cr	BL			
		PBBs	Br	BL			
		PBDEs					

Test results are only responsible for delivered samples. This test report is issued by the company and is intended for your exclusive use. This test report includes all of the testes requested by you and the results thereof based upon the information that you provided. You have 30 days from data of issuance of this test report to notify us of any error or omission caused by our negligence. A failure to raise such issue within the prescribed time shall constitute your unqualified acceptance of the completeness of this report, the tests conducted and the correctness of the report contents.



Test Report

No.: EDG2209210142C00101R

Date: Oct. 08, 2022

Page 49 of 94

No.	Sample description	Restricted substances	Analytical element	Results of EDXRF ⁽¹⁾	Results of Chemical Testing ⁽²⁾ (mg/kg)	Conclusion	Remark
231	SMD IC	Pb	Pb	BL	NA	Pass	No comment
		Cd	Cd	BL			
		Hg	Hg	BL			
		Cr ⁶⁺	Cr	BL			
		PBBs	Br	BL			
		PBDEs					
232	Green PCB	Pb	Pb	BL	NA	Pass	No comment
		Cd	Cd	BL			
		Hg	Hg	BL			
		Cr ⁶⁺	Cr	BL			
		PBBs	Br	BL			
		PBDEs					
233	Silver metal	Pb	Pb	BL	NA	Pass	No comment
		Cd	Cd	BL			
		Hg	Hg	BL			
		Cr ⁶⁺	Cr	BL			
		PBBs	Br	NA			
		PBDEs					
234	Black hard plastic	Pb	Pb	BL	NA	Pass	No comment
		Cd	Cd	BL			
		Hg	Hg	BL			
		Cr ⁶⁺	Cr	BL			
		PBBs	Br	BL			
		PBDEs					
235	Silver metal	Pb	Pb	BL	NA	Pass	No comment
		Cd	Cd	BL			
		Hg	Hg	BL			
		Cr ⁶⁺	Cr	BL			
		PBBs	Br	NA			
		PBDEs					

Test results are only responsible for delivered samples. This test report is issued by the company and is intended for your exclusive use. This test report includes all of the testes requested by you and the results thereof based upon the information that you provided. You have 30 days from data of issuance of this test report to notify us of any error or omission caused by our negligence. A failure to raise such issue within the prescribed time shall constitute your unqualified acceptance of the completeness of this report, the tests conducted and the correctness of the report contents.



Test Report

No.: EDG2209210142C00101R

Date: Oct. 08, 2022

Page 50 of 94

No.	Sample description	Restricted substances	Analytical element	Results of EDXRF ⁽¹⁾	Results of Chemical Testing ⁽²⁾ (mg/kg)	Conclusion	Remark
236	Silver metal	Pb	Pb	BL	NA	Pass	No comment
		Cd	Cd	BL			
		Hg	Hg	BL			
		Cr ⁶⁺	Cr	BL			
		PBBs	Br	NA			
		PBDEs					
237	Black PCB	Pb	Pb	BL	NA	Pass	No comment
		Cd	Cd	BL			
		Hg	Hg	BL			
		Cr ⁶⁺	Cr	BL			
		PBBs	Br	BL			
		PBDEs					
238	Black solid	Pb	Pb	BL	NA	Pass	No comment
		Cd	Cd	BL			
		Hg	Hg	BL			
		Cr ⁶⁺	Cr	BL			
		PBBs	Br	BL			
		PBDEs					
239	SMD capacitor	Pb	Pb	BL	NA	Pass	No comment
		Cd	Cd	BL			
		Hg	Hg	BL			
		Cr ⁶⁺	Cr	BL			
		PBBs	Br	BL			
		PBDEs					
240	Label	Pb	Pb	BL	NA	Pass	No comment
		Cd	Cd	BL			
		Hg	Hg	BL			
		Cr ⁶⁺	Cr	BL			
		PBBs	Br	BL			
		PBDEs					

Test results are only responsible for delivered samples. This test report is issued by the company and is intended for your exclusive use. This test report includes all of the testes requested by you and the results thereof based upon the information that you provided. You have 30 days from data of issuance of this test report to notify us of any error or omission caused by our negligence. A failure to raise such issue within the prescribed time shall constitute your unqualified acceptance of the completeness of this report, the tests conducted and the correctness of the report contents.



Test Report

No.: EDG2209210142C00101R

Date: Oct. 08, 2022

Page 51 of 94

No.	Sample description	Restricted substances	Analytical element	Results of EDXRF ⁽¹⁾	Results of Chemical Testing ⁽²⁾ (mg/kg)	Conclusion	Remark
241	Black solid	Pb	Pb	BL	NA	Pass	No comment
		Cd	Cd	BL			
		Hg	Hg	BL			
		Cr ⁶⁺	Cr	BL			
		PBBs	Br	BL			
		PBDEs					
242	SMD resister	Pb	Pb	BL	NA	Pass	No comment
		Cd	Cd	BL			
		Hg	Hg	BL			
		Cr ⁶⁺	Cr	BL			
		PBBs	Br	BL			
		PBDEs					
243	SMD capacitor	Pb	Pb	BL	NA	Pass	No comment
		Cd	Cd	BL			
		Hg	Hg	BL			
		Cr ⁶⁺	Cr	BL			
		PBBs	Br	BL			
		PBDEs					
244	SMD resister	Pb	Pb	BL	NA	Pass	No comment
		Cd	Cd	BL			
		Hg	Hg	BL			
		Cr ⁶⁺	Cr	BL			
		PBBs	Br	BL			
		PBDEs					
245	Black PCB	Pb	Pb	BL	NA	Pass	No comment
		Cd	Cd	BL			
		Hg	Hg	BL			
		Cr ⁶⁺	Cr	BL			
		PBBs	Br	X	ND		
		PBDEs			ND		

Test results are only responsible for delivered samples. This test report is issued by the company and is intended for your exclusive use. This test report includes all of the testes requested by you and the results thereof based upon the information that you provided. You have 30 days from data of issuance of this test report to notify us of any error or omission caused by our negligence. A failure to raise such issue within the prescribed time shall constitute your unqualified acceptance of the completeness of this report, the tests conducted and the correctness of the report contents.



Test Report

No.: EDG2209210142C00101R

Date: Oct. 08, 2022

Page 52 of 94

No.	Sample description	Restricted substances	Analytical element	Results of EDXRF ⁽¹⁾	Results of Chemical Testing ⁽²⁾ (mg/kg)	Conclusion	Remark
246	SMD capacitor	Pb	Pb	BL	NA	Pass	No comment
		Cd	Cd	BL			
		Hg	Hg	BL			
		Cr ⁶⁺	Cr	BL			
		PBBs	Br	BL			
		PBDEs					
247	Label	Pb	Pb	BL	NA	Pass	No comment
		Cd	Cd	BL			
		Hg	Hg	BL			
		Cr ⁶⁺	Cr	BL			
		PBBs	Br	BL			
		PBDEs					
248	SMD resister	Pb	Pb	BL	NA	Pass	No comment
		Cd	Cd	BL			
		Hg	Hg	BL			
		Cr ⁶⁺	Cr	BL			
		PBBs	Br	BL			
		PBDEs					
249	Silver metal	Pb	Pb	BL	NA	Pass	No comment
		Cd	Cd	BL			
		Hg	Hg	BL			
		Cr ⁶⁺	Cr	BL			
		PBBs	Br	NA			
		PBDEs					
250	SMD capacitor	Pb	Pb	BL	NA	Pass	No comment
		Cd	Cd	BL			
		Hg	Hg	BL			
		Cr ⁶⁺	Cr	BL			
		PBBs	Br	BL			
		PBDEs					

Test results are only responsible for delivered samples. This test report is issued by the company and is intended for your exclusive use. This test report includes all of the testes requested by you and the results thereof based upon the information that you provided. You have 30 days from data of issuance of this test report to notify us of any error or omission caused by our negligence. A failure to raise such issue within the prescribed time shall constitute your unqualified acceptance of the completeness of this report, the tests conducted and the correctness of the report contents.



Test Report

No.: EDG2209210142C00101R

Date: Oct. 08, 2022

Page 53 of 94

No.	Sample description	Restricted substances	Analytical element	Results of EDXRF ⁽¹⁾	Results of Chemical Testing ⁽²⁾ (mg/kg)	Conclusion	Remark
251	Black solid	Pb	Pb	BL	NA	Pass	No comment
		Cd	Cd	BL			
		Hg	Hg	BL			
		Cr ⁶⁺	Cr	BL			
		PBBs	Br	BL			
		PBDEs					
252	SMD IC	Pb	Pb	BL	NA	Pass	No comment
		Cd	Cd	BL			
		Hg	Hg	BL			
		Cr ⁶⁺	Cr	BL			
		PBBs	Br	BL			
		PBDEs					
253	SMD IC	Pb	Pb	BL	NA	Pass	No comment
		Cd	Cd	BL			
		Hg	Hg	BL			
		Cr ⁶⁺	Cr	BL			
		PBBs	Br	BL			
		PBDEs					
254	SMD inductor	Pb	Pb	BL	NA	Pass	No comment
		Cd	Cd	BL			
		Hg	Hg	BL			
		Cr ⁶⁺	Cr	BL			
		PBBs	Br	BL			
		PBDEs					
255	SMD IC	Pb	Pb	BL	NA	Pass	No comment
		Cd	Cd	BL			
		Hg	Hg	BL			
		Cr ⁶⁺	Cr	BL			
		PBBs	Br	BL			
		PBDEs					

Test results are only responsible for delivered samples. This test report is issued by the company and is intended for your exclusive use. This test report includes all of the testes requested by you and the results thereof based upon the information that you provided. You have 30 days from data of issuance of this test report to notify us of any error or omission caused by our negligence. A failure to raise such issue within the prescribed time shall constitute your unqualified acceptance of the completeness of this report, the tests conducted and the correctness of the report contents.



Test Report

No.: EDG2209210142C00101R

Date: Oct. 08, 2022

Page 54 of 94

No.	Sample description	Restricted substances	Analytical element	Results of EDXRF ⁽¹⁾	Results of Chemical Testing ⁽²⁾ (mg/kg)	Conclusion	Remark
256	SMD resister	Pb	Pb	BL	NA	Pass	No comment
		Cd	Cd	BL			
		Hg	Hg	BL			
		Cr ⁶⁺	Cr	BL			
		PBBs	Br	BL			
		PBDEs					
257	White hard plastic	Pb	Pb	BL	NA	Pass	No comment
		Cd	Cd	BL			
		Hg	Hg	BL			
		Cr ⁶⁺	Cr	BL			
		PBBs	Br	BL			
		PBDEs					
258	Silver metal	Pb	Pb	BL	NA	Pass	No comment
		Cd	Cd	BL			
		Hg	Hg	BL			
		Cr ⁶⁺	Cr	BL			
		PBBs	Br	NA			
		PBDEs					
259	Red soft plastic	Pb	Pb	BL	NA	Pass	No comment
		Cd	Cd	BL			
		Hg	Hg	BL			
		Cr ⁶⁺	Cr	BL			
		PBBs	Br	BL			
		PBDEs					
260	Black soft plastic	Pb	Pb	BL	NA	Pass	No comment
		Cd	Cd	BL			
		Hg	Hg	BL			
		Cr ⁶⁺	Cr	BL			
		PBBs	Br	BL			
		PBDEs					

Test results are only responsible for delivered samples. This test report is issued by the company and is intended for your exclusive use. This test report includes all of the testes requested by you and the results thereof based upon the information that you provided. You have 30 days from data of issuance of this test report to notify us of any error or omission caused by our negligence. A failure to raise such issue within the prescribed time shall constitute your unqualified acceptance of the completeness of this report, the tests conducted and the correctness of the report contents.



Test Report

No.: EDG2209210142C00101R

Date: Oct. 08, 2022

Page 55 of 94

No.	Sample description	Restricted substances	Analytical element	Results of EDXRF ⁽¹⁾	Results of Chemical Testing ⁽²⁾ (mg/kg)	Conclusion	Remark
261	Silver metal	Pb	Pb	BL	NA	Pass	No comment
		Cd	Cd	BL			
		Hg	Hg	BL			
		Cr ⁶⁺	Cr	BL			
		PBBs	Br	NA			
		PBDEs					
262	Yellow plastic film	Pb	Pb	BL	NA	Pass	No comment
		Cd	Cd	BL			
		Hg	Hg	BL			
		Cr ⁶⁺	Cr	BL			
		PBBs	Br	BL			
		PBDEs					
263	White foam	Pb	Pb	BL	NA	Pass	No comment
		Cd	Cd	BL			
		Hg	Hg	BL			
		Cr ⁶⁺	Cr	BL			
		PBBs	Br	BL			
		PBDEs					
264	Silver metal	Pb	Pb	BL	NA	Pass	No comment
		Cd	Cd	BL			
		Hg	Hg	BL			
		Cr ⁶⁺	Cr	BL			
		PBBs	Br	NA			
		PBDEs					
265	Black hard plastic	Pb	Pb	BL	NA	Pass	No comment
		Cd	Cd	BL			
		Hg	Hg	BL			
		Cr ⁶⁺	Cr	BL			
		PBBs	Br	BL			
		PBDEs					

Test results are only responsible for delivered samples. This test report is issued by the company and is intended for your exclusive use. This test report includes all of the testes requested by you and the results thereof based upon the information that you provided. You have 30 days from data of issuance of this test report to notify us of any error or omission caused by our negligence. A failure to raise such issue within the prescribed time shall constitute your unqualified acceptance of the completeness of this report, the tests conducted and the correctness of the report contents.



Test Report

No.: EDG2209210142C00101R

Date: Oct. 08, 2022

Page 56 of 94

No.	Sample description	Restricted substances	Analytical element	Results of EDXRF ⁽¹⁾	Results of Chemical Testing ⁽²⁾ (mg/kg)	Conclusion	Remark
266	Silver metal	Pb	Pb	BL	NA	Pass	No comment
		Cd	Cd	BL			
		Hg	Hg	BL			
		Cr ⁶⁺	Cr	BL			
		PBBs	Br	NA			
		PBDEs					
267	Orange hard plastic	Pb	Pb	BL	NA	Pass	No comment
		Cd	Cd	BL			
		Hg	Hg	BL			
		Cr ⁶⁺	Cr	BL			
		PBBs	Br	BL			
		PBDEs					
268	Silver metal with black coating	Pb	Pb	BL	NA	Pass	No comment
		Cd	Cd	BL			
		Hg	Hg	BL			
		Cr ⁶⁺	Cr	BL			
		PBBs	Br	NA			
		PBDEs					

Test results are only responsible for delivered samples. This test report is issued by the company and is intended for your exclusive use. This test report includes all of the testes requested by you and the results thereof based upon the information that you provided. You have 30 days from data of issuance of this test report to notify us of any error or omission caused by our negligence. A failure to raise such issue within the prescribed time shall constitute your unqualified acceptance of the completeness of this report, the tests conducted and the correctness of the report contents.



Test Report

No.: EDG2209210142C00101R

Date: Oct. 08, 2022

Page 57 of 94

Test Results:

2. Phthalates (DBP, BBP, DEHP, DIBP) Test Results:

Test Item	Test Result (mg/kg)			MDL (mg/kg)	Requirement Limit (mg/kg)
	1/8	12/14/15	17/18/19		
Dibutyl phthalate(DBP)	ND	ND	ND	30	1000
Benzylbutyl phthalate(BBP)	ND	ND	ND	30	1000
Di-2-ethylhexyl phthalate(DEHP)	ND	ND	ND	30	1000
Diisobutyl phthalate(DIBP)	ND	ND	ND	30	1000
Conclusion	Pass	Pass	Pass	---	---

Test Item	Test Result (mg/kg)				MDL (mg/kg)	Requirement Limit (mg/kg)
	20/21/25	26/27/28	29/31/32	34/35/36		
Dibutyl phthalate(DBP)	ND	ND	ND	ND	30	1000
Benzylbutyl phthalate(BBP)	ND	ND	ND	ND	30	1000
Di-2-ethylhexyl phthalate(DEHP)	ND	ND	ND	ND	30	1000
Diisobutyl phthalate(DIBP)	ND	ND	ND	ND	30	1000
Conclusion	Pass	Pass	Pass	Pass	---	---

Test Item	Test Result (mg/kg)				MDL (mg/kg)	Requirement Limit (mg/kg)
	40/41/42	43/44/45	46/48/49	50/51/53		
Dibutyl phthalate(DBP)	ND	ND	ND	ND	30	1000
Benzylbutyl phthalate(BBP)	ND	ND	ND	ND	30	1000
Di-2-ethylhexyl phthalate(DEHP)	ND	ND	ND	ND	30	1000
Diisobutyl phthalate(DIBP)	ND	ND	ND	ND	30	1000
Conclusion	Pass	Pass	Pass	Pass	---	---

Test Item	Test Result (mg/kg)				MDL (mg/kg)	Requirement Limit (mg/kg)
	54/55/56	58/59/60	61/62/63	64/65/66		
Dibutyl phthalate(DBP)	ND	ND	ND	ND	30	1000
Benzylbutyl phthalate(BBP)	ND	ND	ND	ND	30	1000
Di-2-ethylhexyl phthalate(DEHP)	ND	ND	ND	ND	30	1000
Diisobutyl phthalate(DIBP)	ND	ND	ND	ND	30	1000
Conclusion	Pass	Pass	Pass	Pass	---	---

Test results are only responsible for delivered samples. This test report is issued by the company and is intended for your exclusive use. This test report includes all of the testes requested by you and the results thereof based upon the information that you provided. You have 30 days from data of issuance of this test report to notify us of any error or omission caused by our negligence. A failure to raise such issue within the prescribed time shall constitute your unqualified acceptance of the completeness of this report, the tests conducted and the correctness of the report contents.



Test Report

No.: EDG2209210142C00101R

Date: Oct. 08, 2022

Page 58 of 94

Test Results:

2. Phthalates (DBP, BBP, DEHP, DIBP) Test Results:

Test Item	Test Result (mg/kg)				MDL (mg/kg)	Requirement Limit (mg/kg)
	67/68/69	70/71/72	74/77/79	80/81/82		
Dibutyl phthalate(DBP)	ND	ND	ND	ND	30	1000
Benzylbutyl phthalate(BBP)	ND	ND	ND	ND	30	1000
Di-2-ethylhexyl phthalate(DEHP)	ND	ND	ND	ND	30	1000
Diisobutyl phthalate(DIBP)	ND	ND	ND	ND	30	1000
Conclusion	Pass	Pass	Pass	Pass	---	---

Test Item	Test Result (mg/kg)				MDL (mg/kg)	Requirement Limit (mg/kg)
	83/84/85	87/88/90	91/92/93	95/97/98		
Dibutyl phthalate(DBP)	ND	ND	ND	ND	30	1000
Benzylbutyl phthalate(BBP)	ND	ND	ND	ND	30	1000
Di-2-ethylhexyl phthalate(DEHP)	ND	ND	ND	ND	30	1000
Diisobutyl phthalate(DIBP)	ND	ND	ND	ND	30	1000
Conclusion	Pass	Pass	Pass	Pass	---	---

Test Item	Test Result (mg/kg)			MDL (mg/kg)	Requirement Limit (mg/kg)
	100/101/102	103/105/106	108/109/113		
Dibutyl phthalate(DBP)	ND	ND	ND	30	1000
Benzylbutyl phthalate(BBP)	ND	ND	ND	30	1000
Di-2-ethylhexyl phthalate(DEHP)	ND	ND	ND	30	1000
Diisobutyl phthalate(DIBP)	ND	ND	ND	30	1000
Conclusion	Pass	Pass	Pass	---	---

Test Item	Test Result (mg/kg)			MDL (mg/kg)	Requirement Limit (mg/kg)
	114/115/117	120/122/123	124/126/128		
Dibutyl phthalate(DBP)	ND	ND	ND	30	1000
Benzylbutyl phthalate(BBP)	ND	ND	ND	30	1000
Di-2-ethylhexyl phthalate(DEHP)	ND	ND	ND	30	1000
Diisobutyl phthalate(DIBP)	ND	ND	ND	30	1000
Conclusion	Pass	Pass	Pass	---	---

Test results are only responsible for delivered samples. This test report is issued by the company and is intended for your exclusive use. This test report includes all of the testes requested by you and the results thereof based upon the information that you provided. You have 30 days from data of issuance of this test report to notify us of any error or omission caused by our negligence. A failure to raise such issue within the prescribed time shall constitute your unqualified acceptance of the completeness of this report, the tests conducted and the correctness of the report contents.



Test Report

No.: EDG2209210142C00101R

Date: Oct. 08, 2022

Page 59 of 94

Test Results:

2. Phthalates (DBP, BBP, DEHP, DIBP) Test Results:

Test Item	Test Result (mg/kg)			MDL (mg/kg)	Requirement Limit (mg/kg)
	129/130/131	133/137/138	139/140/141		
Dibutyl phthalate(DBP)	ND	ND	ND	30	1000
Benzylbutyl phthalate(BBP)	ND	ND	ND	30	1000
Di-2-ethylhexyl phthalate(DEHP)	ND	ND	ND	30	1000
Diisobutyl phthalate(DIBP)	ND	ND	ND	30	1000
Conclusion	Pass	Pass	Pass	---	---

Test Item	Test Result (mg/kg)			MDL (mg/kg)	Requirement Limit (mg/kg)
	142/143/146	147/148/149	151/152/153		
Dibutyl phthalate(DBP)	ND	ND	ND	30	1000
Benzylbutyl phthalate(BBP)	ND	ND	ND	30	1000
Di-2-ethylhexyl phthalate(DEHP)	ND	ND	ND	30	1000
Diisobutyl phthalate(DIBP)	ND	ND	ND	30	1000
Conclusion	Pass	Pass	Pass	---	---

Test Item	Test Result (mg/kg)			MDL (mg/kg)	Requirement Limit (mg/kg)
	155/156/157	159/162/164	166/168/171		
Dibutyl phthalate(DBP)	ND	ND	ND	30	1000
Benzylbutyl phthalate(BBP)	ND	ND	ND	30	1000
Di-2-ethylhexyl phthalate(DEHP)	ND	ND	ND	30	1000
Diisobutyl phthalate(DIBP)	ND	ND	ND	30	1000
Conclusion	Pass	Pass	Pass	---	---

Test Item	Test Result (mg/kg)			MDL (mg/kg)	Requirement Limit (mg/kg)
	174/175/177	178/180/182	184/186/188		
Dibutyl phthalate(DBP)	ND	ND	ND	30	1000
Benzylbutyl phthalate(BBP)	ND	ND	ND	30	1000
Di-2-ethylhexyl phthalate(DEHP)	ND	ND	ND	30	1000
Diisobutyl phthalate(DIBP)	ND	ND	ND	30	1000
Conclusion	Pass	Pass	Pass	---	---

Test results are only responsible for delivered samples. This test report is issued by the company and is intended for your exclusive use. This test report includes all of the testes requested by you and the results thereof based upon the information that you provided. You have 30 days from data of issuance of this test report to notify us of any error or omission caused by our negligence. A failure to raise such issue within the prescribed time shall constitute your unqualified acceptance of the completeness of this report, the tests conducted and the correctness of the report contents.



Test Report

No.: EDG2209210142C00101R

Date: Oct. 08, 2022

Page 60 of 94

Test Results:

2. Phthalates (DBP, BBP, DEHP, DIBP) Test Results:

Test Item	Test Result (mg/kg)			MDL (mg/kg)	Requirement Limit (mg/kg)
	190/192/194	196/197/198	199/200/201		
Dibutyl phthalate(DBP)	ND	ND	ND	30	1000
Benzylbutyl phthalate(BBP)	ND	ND	ND	30	1000
Di-2-ethylhexyl phthalate(DEHP)	ND	ND	ND	30	1000
Diisobutyl phthalate(DIBP)	ND	ND	ND	30	1000
Conclusion	Pass	Pass	Pass	---	---

Test Item	Test Result (mg/kg)			MDL (mg/kg)	Requirement Limit (mg/kg)
	202/203/204	205/207/208	209/210/213		
Dibutyl phthalate(DBP)	ND	ND	ND	30	1000
Benzylbutyl phthalate(BBP)	ND	ND	ND	30	1000
Di-2-ethylhexyl phthalate(DEHP)	ND	ND	ND	30	1000
Diisobutyl phthalate(DIBP)	ND	ND	ND	30	1000
Conclusion	Pass	Pass	Pass	---	---

Test Item	Test Result (mg/kg)			MDL (mg/kg)	Requirement Limit (mg/kg)
	214/216/217	219/220/221	222/223/225		
Dibutyl phthalate(DBP)	ND	ND	ND	30	1000
Benzylbutyl phthalate(BBP)	ND	ND	ND	30	1000
Di-2-ethylhexyl phthalate(DEHP)	ND	ND	ND	30	1000
Diisobutyl phthalate(DIBP)	ND	ND	ND	30	1000
Conclusion	Pass	Pass	Pass	---	---

Test Item	Test Result (mg/kg)			MDL (mg/kg)	Requirement Limit (mg/kg)
	226/227/228	230/231/232	234/237/238		
Dibutyl phthalate(DBP)	ND	ND	ND	30	1000
Benzylbutyl phthalate(BBP)	ND	ND	ND	30	1000
Di-2-ethylhexyl phthalate(DEHP)	ND	ND	ND	30	1000
Diisobutyl phthalate(DIBP)	ND	ND	ND	30	1000
Conclusion	Pass	Pass	Pass	---	---

Test results are only responsible for delivered samples. This test report is issued by the company and is intended for your exclusive use. This test report includes all of the testes requested by you and the results thereof based upon the information that you provided. You have 30 days from data of issuance of this test report to notify us of any error or omission caused by our negligence. A failure to raise such issue within the prescribed time shall constitute your unqualified acceptance of the completeness of this report, the tests conducted and the correctness of the report contents.



Test Report

No.: EDG2209210142C00101R

Date: Oct. 08, 2022

Page 61 of 94

Test Results:

2. Phthalates (DBP, BBP, DEHP, DIBP) Test Results:

Test Item	Test Result (mg/kg)			MDL (mg/kg)	Requirement Limit (mg/kg)
	239/240/241	242/243/244	245/246/247		
Dibutyl phthalate(DBP)	ND	ND	ND	30	1000
Benzylbutyl phthalate(BBP)	ND	ND	ND	30	1000
Di-2-ethylhexyl phthalate(DEHP)	ND	ND	ND	30	1000
Diisobutyl phthalate(DIBP)	ND	ND	ND	30	1000
Conclusion	Pass	Pass	Pass	---	---

Test Item	Test Result (mg/kg)			MDL (mg/kg)	Requirement Limit (mg/kg)
	248/250/251	252/253/254	255/256/257		
Dibutyl phthalate(DBP)	ND	ND	ND	30	1000
Benzylbutyl phthalate(BBP)	ND	ND	ND	30	1000
Di-2-ethylhexyl phthalate(DEHP)	ND	ND	ND	30	1000
Diisobutyl phthalate(DIBP)	ND	ND	ND	30	1000
Conclusion	Pass	Pass	Pass	---	---

Test Item	Test Result (mg/kg)			MDL (mg/kg)	Requirement Limit (mg/kg)
	259/260	262/263	265/267		
Dibutyl phthalate(DBP)	179	ND	ND	30	1000
Benzylbutyl phthalate(BBP)	ND	ND	ND	30	1000
Di-2-ethylhexyl phthalate(DEHP)	ND	ND	ND	30	1000
Diisobutyl phthalate(DIBP)	ND	ND	ND	30	1000
Conclusion	Pass	Pass	Pass	---	---

Note: mg/kg = parts per million = ppm ND = Not Detected (less than MDL) MDL = Method Detection Limit

Test results are only responsible for delivered samples. This test report is issued by the company and is intended for your exclusive use. This test report includes all of the testes requested by you and the results thereof based upon the information that you provided. You have 30 days from data of issuance of this test report to notify us of any error or omission caused by our negligence. A failure to raise such issue within the prescribed time shall constitute your unqualified acceptance of the completeness of this report, the tests conducted and the correctness of the report contents.



Test Report

No.: EDG2209210142C00101R

Date: Oct. 08, 2022

Page 62 of 94

Test Materials List:

Item No.	Description
1	Label
8	Grey glue
12	White hard plastic
14	Red soft plastic
15	Black soft plastic
17	Black soft plastic
18	Yellow glue
19	Label
20	Black hard plastic
21	Black solid
25	Black hard plastic
26	Green PCB
27	Black solid
28	SMD resister
29	SMD capacitor
31	Green PCB
32	Black solid
34	Black solid
35	Black soft plastic
36	Brown paper
40	Black hard plastic
41	Grey solid
42	Green PCB
43	Grey solid
44	SMD triode
45	SMD resister
46	SMD resister
48	Dark grey solid
49	Dark grey solid

Test results are only responsible for delivered samples. This test report is issued by the company and is intended for your exclusive use. This test report includes all of the testes requested by you and the results thereof based upon the information that you provided. You have 30 days from data of issuance of this test report to notify us of any error or omission caused by our negligence. A failure to raise such issue within the prescribed time shall constitute your unqualified acceptance of the completeness of this report, the tests conducted and the correctness of the report contents.



Test Report

No.: EDG2209210142C00101R

Date: Oct. 08, 2022

Page 63 of 94

Item No.	Description
50	Copper enameled wire
51	SMD IC
53	SMD diode
54	Black solid
55	SMD LED
56	Black hard plastic
58	SMD diode
59	SMD capacitor
60	SMD IC
61	SMD diode
62	Black hard plastic
63	Grey solid
64	Green PCB
65	SMD capacitor
66	SMD IC
67	SMD inductor
68	SMD IC
69	SMD capacitor
70	SMD IC
71	Blue soft plastic with white printing
72	Black soft plastic
74	Brown paper
77	Transparent glue tape
79	SMD IC
80	SMD diode
81	Grey solid
82	SMD inductor
83	Black solid
84	Yellow solid
85	Black hard plastic

Test results are only responsible for delivered samples. This test report is issued by the company and is intended for your exclusive use. This test report includes all of the testes requested by you and the results thereof based upon the information that you provided. You have 30 days from data of issuance of this test report to notify us of any error or omission caused by our negligence. A failure to raise such issue within the prescribed time shall constitute your unqualified acceptance of the completeness of this report, the tests conducted and the correctness of the report contents.



Test Report

No.: EDG2209210142C00101R

Date: Oct. 08, 2022

Page 64 of 94

Item No.	Description
87	SMD diode
88	Dark grey solid
90	SMD diode
91	Black solid
92	Black solid
93	SMD resister
95	Yellow solid
97	Green PCB
98	Grey solid
100	Dark grey solid
101	SMD resister
102	SMD triode
103	Black hard plastic
105	SMD capacitor
106	SMD diode
108	Black soft plastic
109	Brown paper
113	SMD IC
114	SMD IC
115	SMD IC
117	Dark grey solid
120	Black solid
122	SMD inductor
123	Black hard plastic
124	SMD inductor
126	Green hard plastic
128	Blue solid
129	Black solid
130	Black soft plastic with grey printing
131	Black soft plastic

Test results are only responsible for delivered samples. This test report is issued by the company and is intended for your exclusive use. This test report includes all of the testes requested by you and the results thereof based upon the information that you provided. You have 30 days from data of issuance of this test report to notify us of any error or omission caused by our negligence. A failure to raise such issue within the prescribed time shall constitute your unqualified acceptance of the completeness of this report, the tests conducted and the correctness of the report contents.



Test Report

No.: EDG2209210142C00101R

Date: Oct. 08, 2022

Page 65 of 94

Item No.	Description
133	Brown paper
137	SMD capacitor
138	SMD IC
139	SMD resister
140	SMD diode
141	SMD resister
142	Yellow solid
143	White ceramic
146	SMD diode
147	SMD IC
148	Silver fabric
149	Black foam
151	Dark grey hard plastic
152	Black hard plastic
153	Translucent hard plastic with silver coating
155	Black hard plastic
156	Green transparent hard plastic
157	Red transparent hard plastic
159	Black hard plastic
162	Black hard plastic
164	Label
166	Black hard plastic
168	Black hard plastic
171	Black hard plastic
174	Green PCB
175	Black hard plastic
177	Black hard plastic
178	SMD capacitor
180	Blue hard plastic
182	Beige hard plastic

Test results are only responsible for delivered samples. This test report is issued by the company and is intended for your exclusive use. This test report includes all of the testes requested by you and the results thereof based upon the information that you provided. You have 30 days from data of issuance of this test report to notify us of any error or omission caused by our negligence. A failure to raise such issue within the prescribed time shall constitute your unqualified acceptance of the completeness of this report, the tests conducted and the correctness of the report contents.



Test Report

No.: EDG2209210142C00101R

Date: Oct. 08, 2022

Page 66 of 94

Item No.	Description
184	Black solid
186	SMD IC
188	SMD IC
190	Grey hard plastic
192	Black hard plastic
194	Black hard plastic
196	SMD IC
197	SMD IC
198	SMD resister
199	Green PCB
200	Brown solid
201	Black solid
202	SMD capacitor
203	SMD IC
204	Grey solid
205	Beige hard plastic
207	SMD resister
208	Black solid
209	Black solid
210	Dark grey hard plastic
213	SMD resister
214	SMD IC
216	Label
217	Dark grey hard plastic
219	Black solid
220	Black solid
221	Black hard plastic
222	Green PCB
223	SMD IC
225	SMD triode

Test results are only responsible for delivered samples. This test report is issued by the company and is intended for your exclusive use. This test report includes all of the testes requested by you and the results thereof based upon the information that you provided. You have 30 days from data of issuance of this test report to notify us of any error or omission caused by our negligence. A failure to raise such issue within the prescribed time shall constitute your unqualified acceptance of the completeness of this report, the tests conducted and the correctness of the report contents.



Test Report

No.: EDG2209210142C00101R

Date: Oct. 08, 2022

Page 67 of 94

Item No.	Description
226	SMD diode
227	Label
228	Brown solid
230	Grey solid
231	SMD IC
232	Green PCB
234	Black hard plastic
237	Black PCB
238	Black solid
239	SMD capacitor
240	Label
241	Black solid
242	SMD resister
243	SMD capacitor
244	SMD resister
245	Black PCB
246	SMD capacitor
247	Label
248	SMD resister
250	SMD capacitor
251	Black solid
252	SMD IC
253	SMD IC
254	SMD inductor
255	SMD IC
256	SMD resister
257	White hard plastic
259	Red soft plastic
260	Black soft plastic
262	Yellow plastic film

Test results are only responsible for delivered samples. This test report is issued by the company and is intended for your exclusive use. This test report includes all of the testes requested by you and the results thereof based upon the information that you provided. You have 30 days from data of issuance of this test report to notify us of any error or omission caused by our negligence. A failure to raise such issue within the prescribed time shall constitute your unqualified acceptance of the completeness of this report, the tests conducted and the correctness of the report contents.



Test Report

No.: EDG2209210142C00101R

Date: Oct. 08, 2022

Page 68 of 94

Item No.	Description
263	White foam
265	Black hard plastic
267	Orange hard plastic

Note: As specified by the client, the samples were subjected to mixed testing.



Test results are only responsible for delivered samples. This test report is issued by the company and is intended for your exclusive use. This test report includes all of the testes requested by you and the results thereof based upon the information that you provided. You have 30 days from data of issuance of this test report to notify us of any error or omission caused by our negligence. A failure to raise such issue within the prescribed time shall constitute your unqualified acceptance of the completeness of this report, the tests conducted and the correctness of the report contents.



Test Report

No.: EDG2209210142C00101R

Date: Oct. 08, 2022

Page 69 of 94

- Remark: (1) ① Results are obtained by XRF for primary screening, and further wet chemical testing by ICP-OES / AAS (for Cd, Pb, Hg), UV-VIS (for Cr(VI)) and GC-MS (for PBBs, PBDEs) is recommended to be performed, if an inconclusive result was found (as "X" in below table) (unit: mg/kg).
- ② OL = Over Limit, BL = Below Limit, X = Inconclusive, NA= Not Applicable.
- ③ XRF screening test for RoHS elements – The test result may be different from the actual content in the non-uniformity composition sample.

Element	Polymer	Metal	Composite Materials
Cd	$BL \leq (70-3\sigma) < X < (130+3\sigma) \leq OL$	$BL \leq (70-3\sigma) < X < (130+3\sigma) \leq OL$	$LOD < X < (150+3\sigma) \leq OL$
Pb	$BL \leq (700-3\sigma) < X < (1300+3\sigma) \leq OL$	$BL \leq (700-3\sigma) < X < (1300+3\sigma) \leq OL$	$BL \leq (500-3\sigma) < X < (1500+3\sigma) \leq OL$
Hg	$BL \leq (700-3\sigma) < X < (1300+3\sigma) \leq OL$	$BL \leq (700-3\sigma) < X < (1300+3\sigma) \leq OL$	$BL \leq (500-3\sigma) < X < (1500+3\sigma) \leq OL$
Br	$BL \leq (300-3\sigma) < X$	NA	$BL \leq (250-3\sigma) < X$
Cr	$BL \leq (700-3\sigma) < X$	$BL \leq (700-3\sigma) < X$	$BL \leq (500-3\sigma) < X$

(2) ① mg/kg = ppm = 0.0001%, ND = Not Detected (less than MDL), MDL = Method Detection Limit.

② Unit, Method Detection Limit (MDL) and Requirement limit in wet chemical test.

Test items	Pb	Cd	Hg	Cr ⁶⁺ (Non-metal)	Cr ⁶⁺ (metal)	PBBs(single)	PBDEs(single)
Unit	mg/kg	mg/kg	mg/kg	mg/kg	mg/kg	mg/kg	mg/kg
MDL	2	2	2	8	---	5	5
Requirement Limit	1000	100	1000	1000	Negative	1000	1000

③ According to IEC 62321-7-1:2015, result on Cr⁶⁺ for metal sample shall be shown as Positive/Negative.

- a) The Cr(VI) concentration is more than 0.13 µg/cm², the sample is positive for Cr(VI), the coating is considered to contain Cr(VI).
- b) The Cr(VI) concentration is less than 0.10 µg/cm², the sample is negative for Cr(VI), the coating is considered a non-Cr(VI) based coating.

Storage condition and production date of the tested sample are unavailable and thus results of Cr⁶⁺ represent status of the sample at the time of testing.

④ According to IEC 62321-3-1:2013, this column represents the results of wet chem test. And "NA" means no need to perform wet chem test, when the XRF screening results are acceptable.

- (3) As declared by the client, No. 99,170 the materials should be exempted for lead content requirement according to Annex clause 6(c); No.44,51,58,61,80,90,129,140,146 the materials should be exempted for lead content requirement according to Annex clause 7(c)-I.
- (4) As specified by the client, the related tests were performed only for the selected materials of submitted sample.

Test results are only responsible for delivered samples. This test report is issued by the company and is intended for your exclusive use. This test report includes all of the testes requested by you and the results thereof based upon the information that you provided. You have 30 days from data of issuance of this test report to notify us of any error or omission caused by our negligence. A failure to raise such issue within the prescribed time shall constitute your unqualified acceptance of the completeness of this report, the tests conducted and the correctness of the report contents.



Test Report

No.: EDG2209210142C00101R

Date: Oct. 08, 2022

Page 70 of 94

Sample Photo



Test results are only responsible for delivered samples. This test report is issued by the company and is intended for your exclusive use. This test report includes all of the testes requested by you and the results thereof based upon the information that you provided. You have 30 days from data of issuance of this test report to notify us of any error or omission caused by our negligence. A failure to raise such issue within the prescribed time shall constitute your unqualified acceptance of the completeness of this report, the tests conducted and the correctness of the report contents.



Test Report

No.: EDG2209210142C00101R

Date: Oct. 08, 2022

Page 71 of 94

Sample Photo

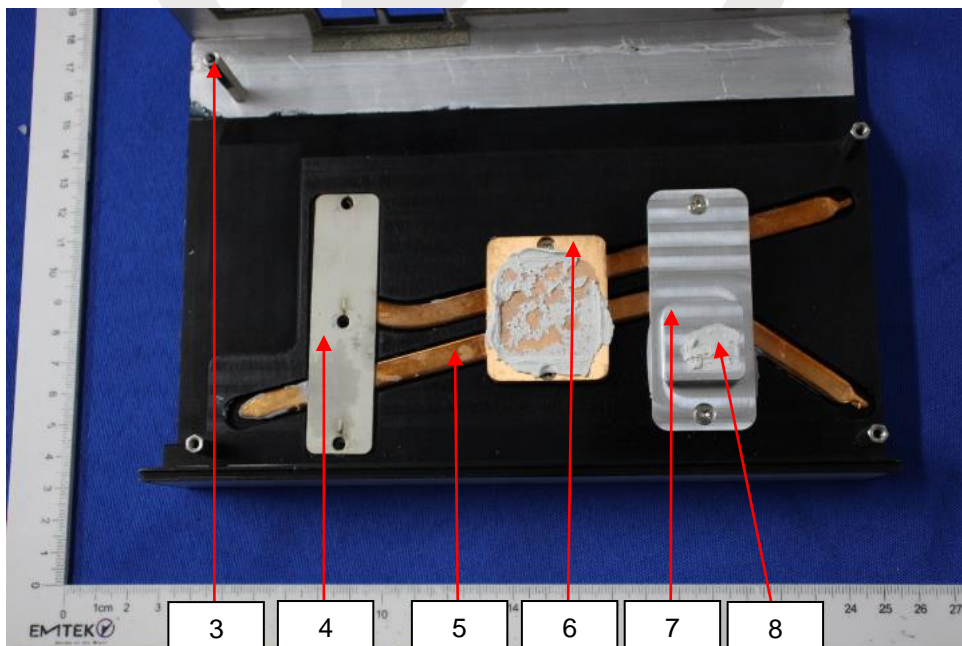
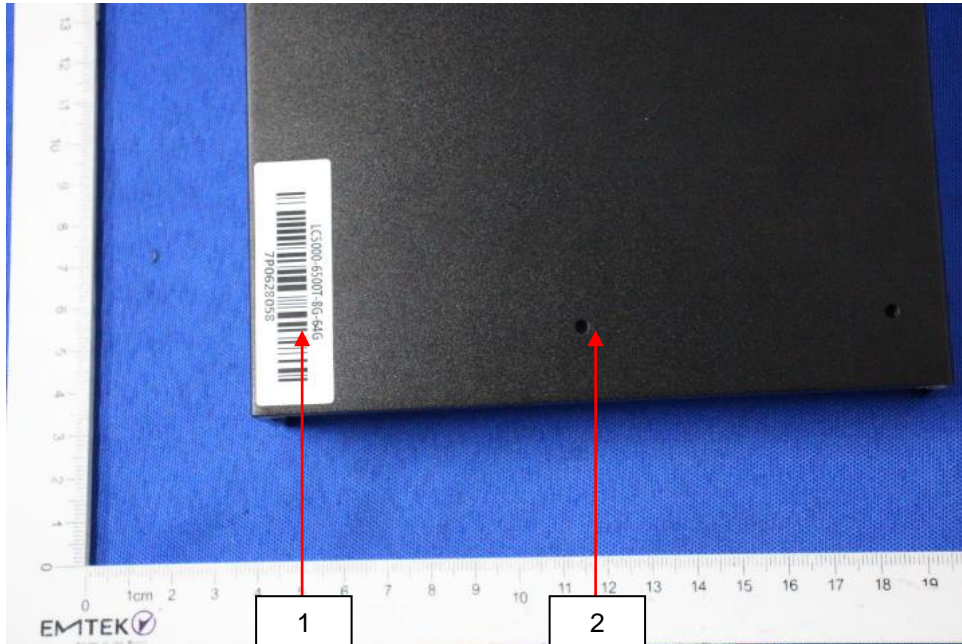

Test results are only responsible for delivered samples. This test report is issued by the company and is intended for your exclusive use. This test report includes all of the testes requested by you and the results thereof based upon the information that you provided. You have 30 days from data of issuance of this test report to notify us of any error or omission caused by our negligence. A failure to raise such issue within the prescribed time shall constitute your unqualified acceptance of the completeness of this report, the tests conducted and the correctness of the report contents.



Test Report

No.: EDG2209210142C00101R

Date: Oct. 08, 2022

Page 72 of 94

Sample Photo

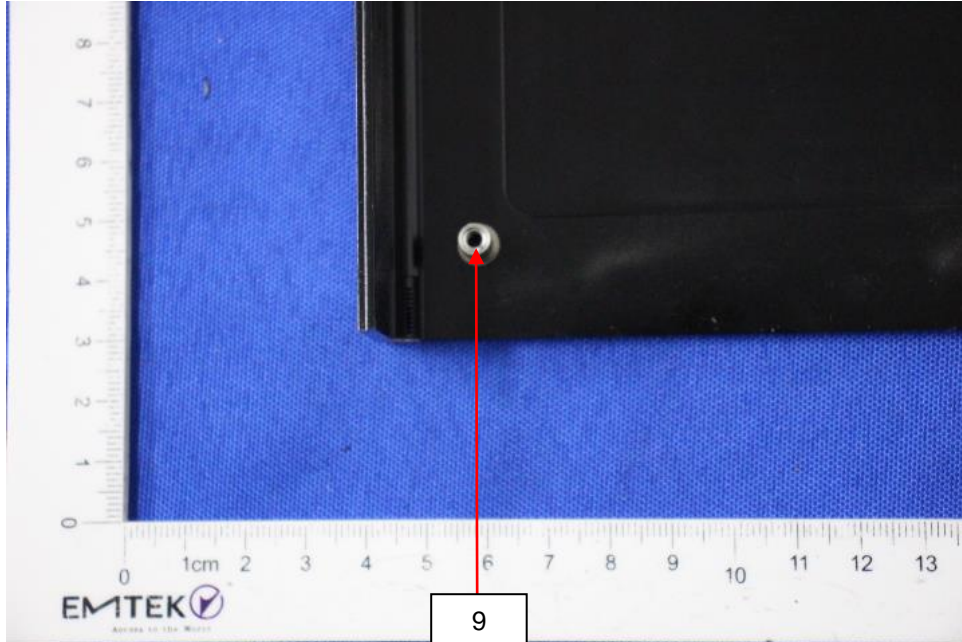

Test results are only responsible for delivered samples. This test report is issued by the company and is intended for your exclusive use. This test report includes all of the testes requested by you and the results thereof based upon the information that you provided. You have 30 days from data of issuance of this test report to notify us of any error or omission caused by our negligence. A failure to raise such issue within the prescribed time shall constitute your unqualified acceptance of the completeness of this report, the tests conducted and the correctness of the report contents.



Test Report

No.: EDG2209210142C00101R

Date: Oct. 08, 2022

Page 73 of 94

Sample Photo

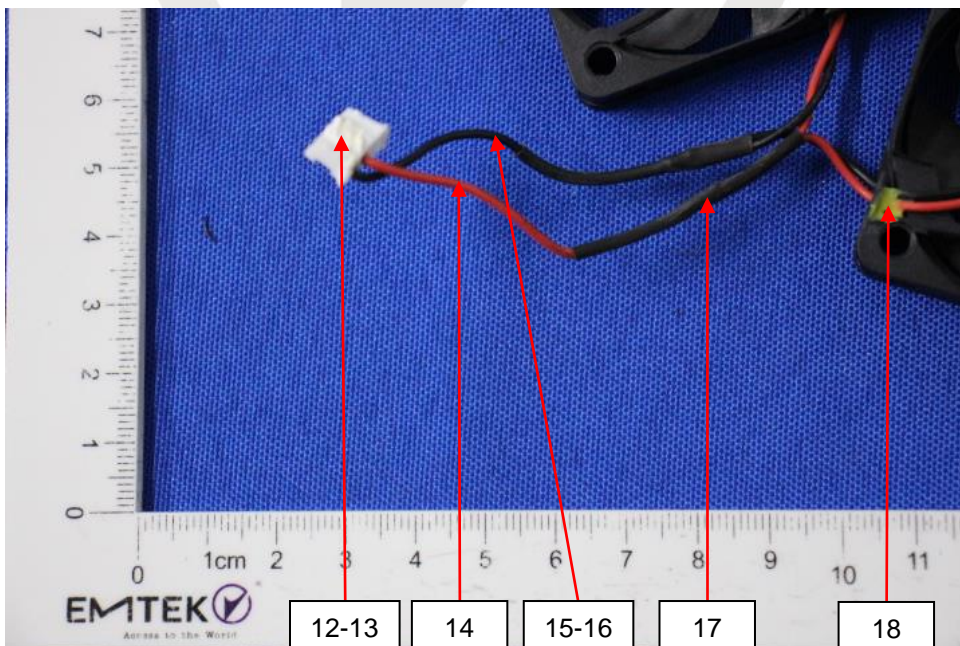

Test results are only responsible for delivered samples. This test report is issued by the company and is intended for your exclusive use. This test report includes all of the testes requested by you and the results thereof based upon the information that you provided. You have 30 days from data of issuance of this test report to notify us of any error or omission caused by our negligence. A failure to raise such issue within the prescribed time shall constitute your unqualified acceptance of the completeness of this report, the tests conducted and the correctness of the report contents.



Test Report

No.: EDG2209210142C00101R

Date: Oct. 08, 2022

Page 74 of 94

Sample Photo

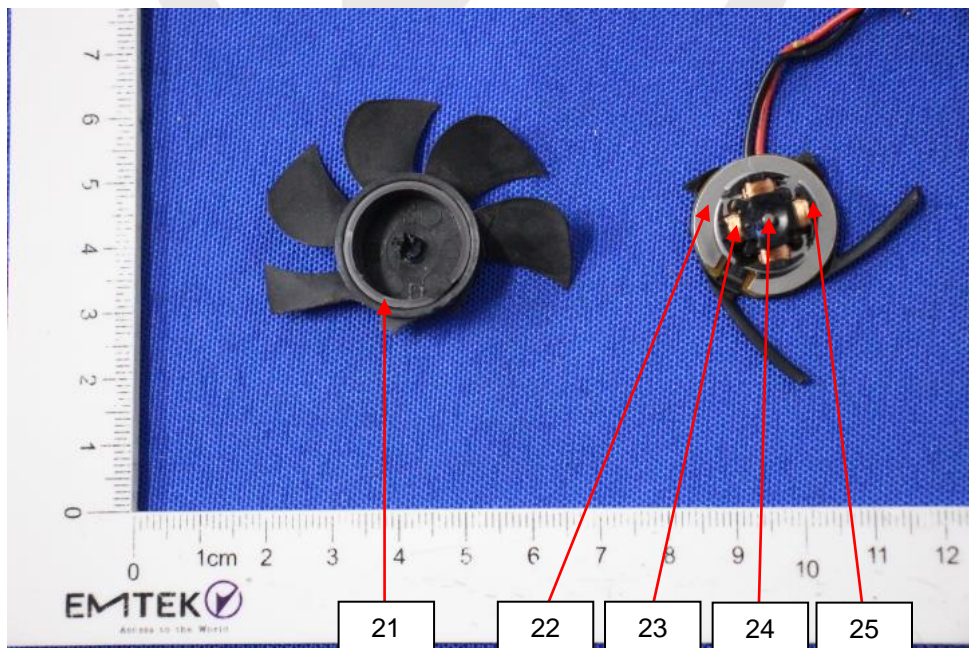
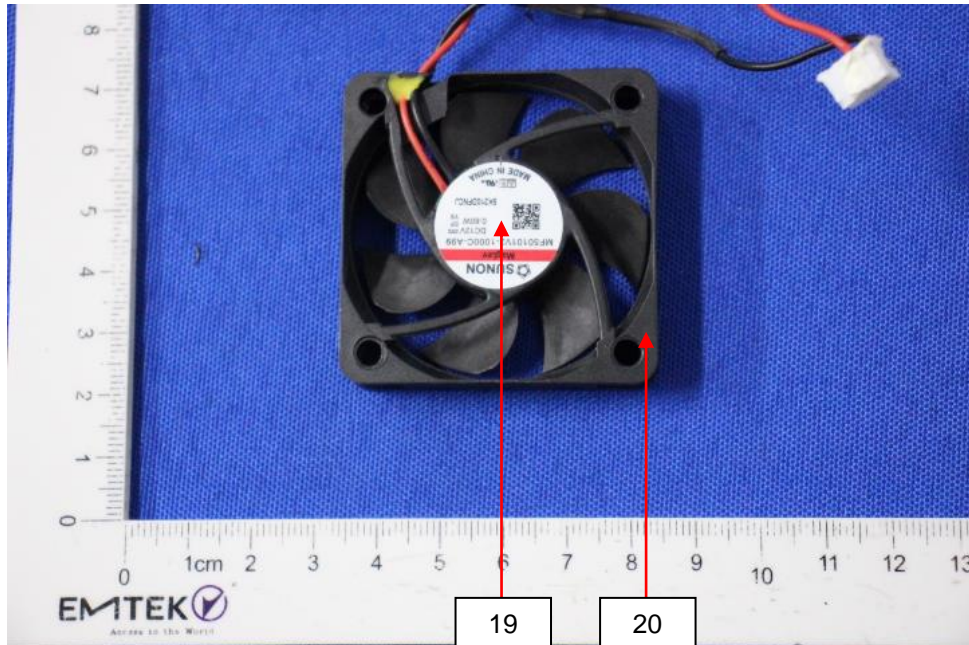

Test results are only responsible for delivered samples. This test report is issued by the company and is intended for your exclusive use. This test report includes all of the testes requested by you and the results thereof based upon the information that you provided. You have 30 days from data of issuance of this test report to notify us of any error or omission caused by our negligence. A failure to raise such issue within the prescribed time shall constitute your unqualified acceptance of the completeness of this report, the tests conducted and the correctness of the report contents.



Test Report

No.: EDG2209210142C00101R

Date: Oct. 08, 2022

Page 75 of 94

Sample Photo

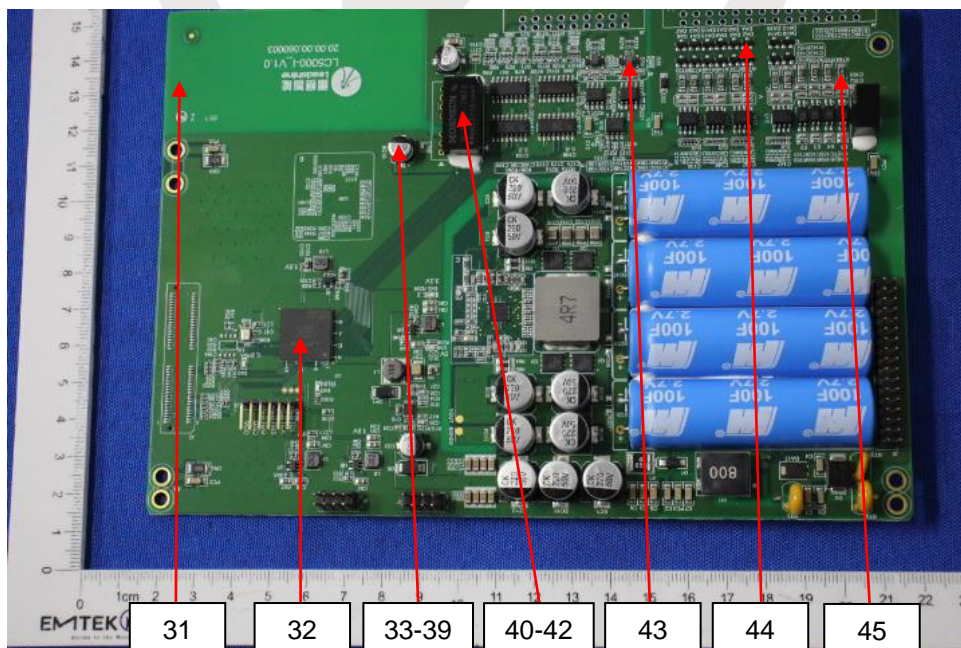
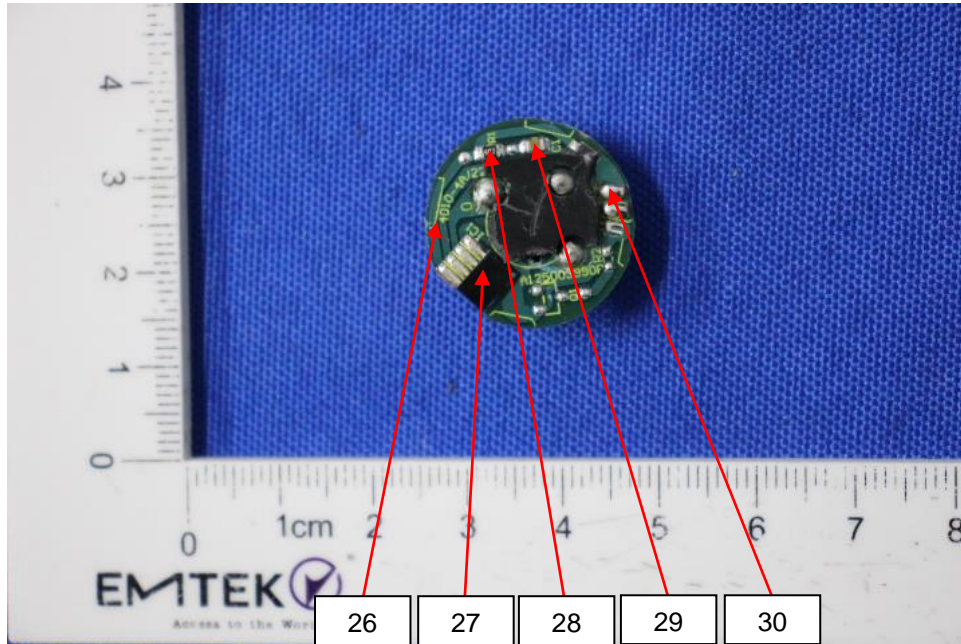

Test results are only responsible for delivered samples. This test report is issued by the company and is intended for your exclusive use. This test report includes all of the testes requested by you and the results thereof based upon the information that you provided. You have 30 days from data of issuance of this test report to notify us of any error or omission caused by our negligence. A failure to raise such issue within the prescribed time shall constitute your unqualified acceptance of the completeness of this report, the tests conducted and the correctness of the report contents.



Test Report

No.: EDG2209210142C00101R

Date: Oct. 08, 2022

Page 76 of 94

Sample Photo

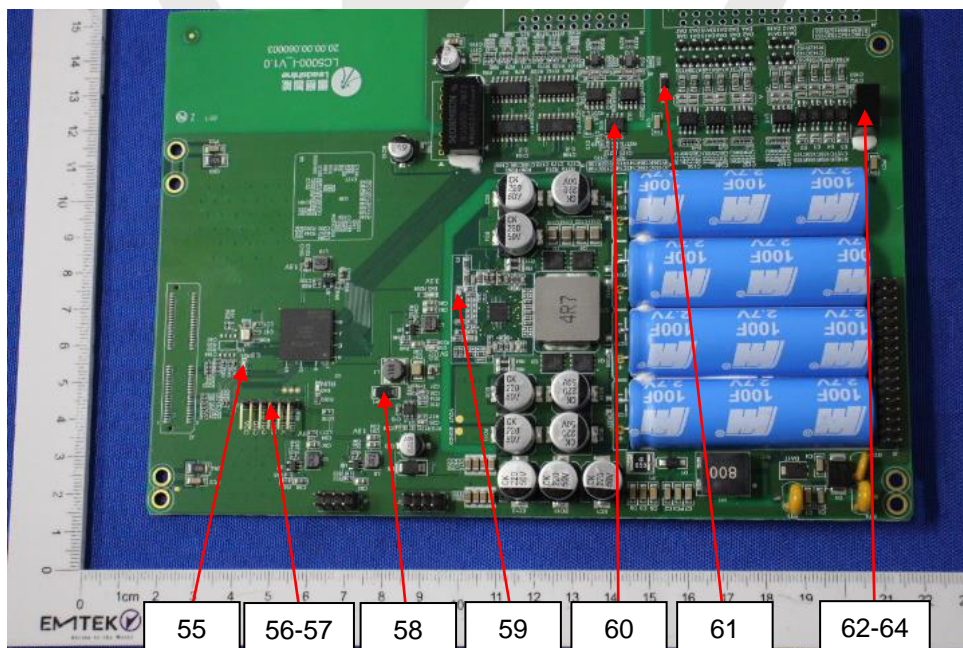
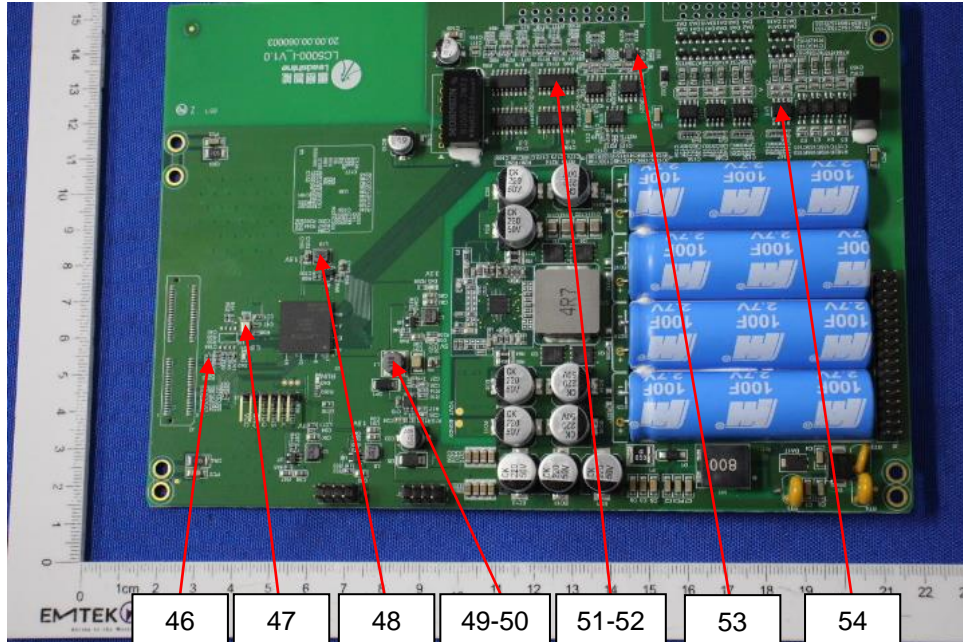

Test results are only responsible for delivered samples. This test report is issued by the company and is intended for your exclusive use. This test report includes all of the testes requested by you and the results thereof based upon the information that you provided. You have 30 days from data of issuance of this test report to notify us of any error or omission caused by our negligence. A failure to raise such issue within the prescribed time shall constitute your unqualified acceptance of the completeness of this report, the tests conducted and the correctness of the report contents.



Test Report

No.: EDG2209210142C00101R

Date: Oct. 08, 2022

Page 77 of 94

Sample Photo

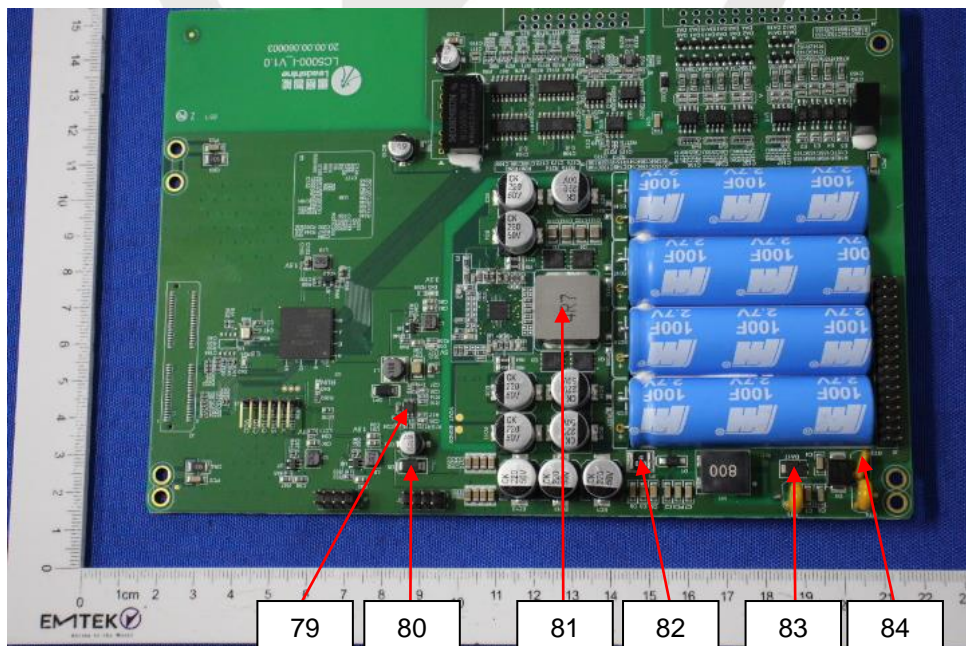
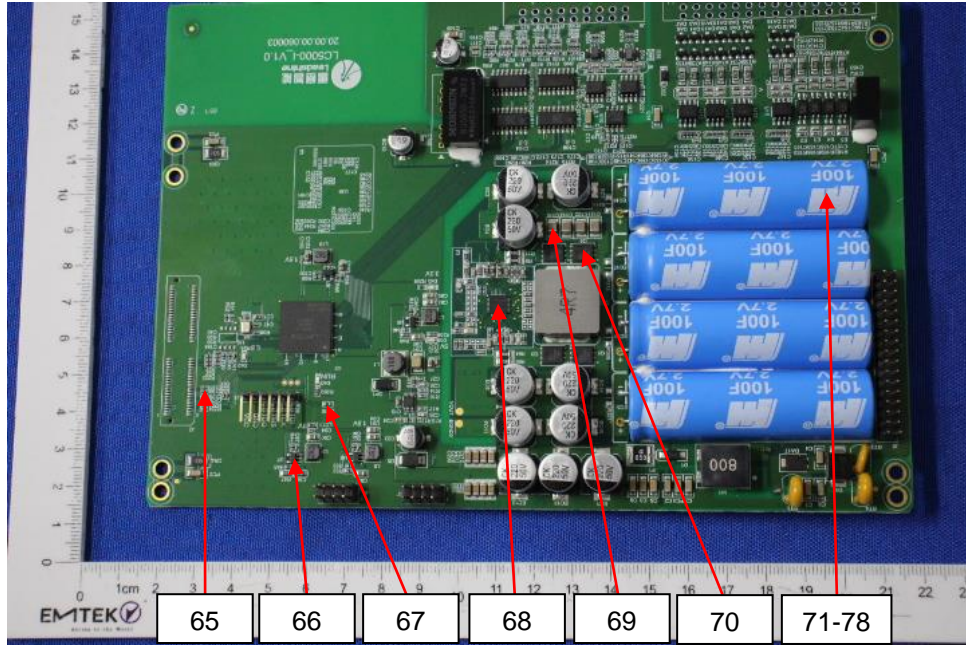

Test results are only responsible for delivered samples. This test report is issued by the company and is intended for your exclusive use. This test report includes all of the testes requested by you and the results thereof based upon the information that you provided. You have 30 days from data of issuance of this test report to notify us of any error or omission caused by our negligence. A failure to raise such issue within the prescribed time shall constitute your unqualified acceptance of the completeness of this report, the tests conducted and the correctness of the report contents.



Test Report

No.: EDG2209210142C00101R

Date: Oct. 08, 2022

Page 78 of 94

Sample Photo

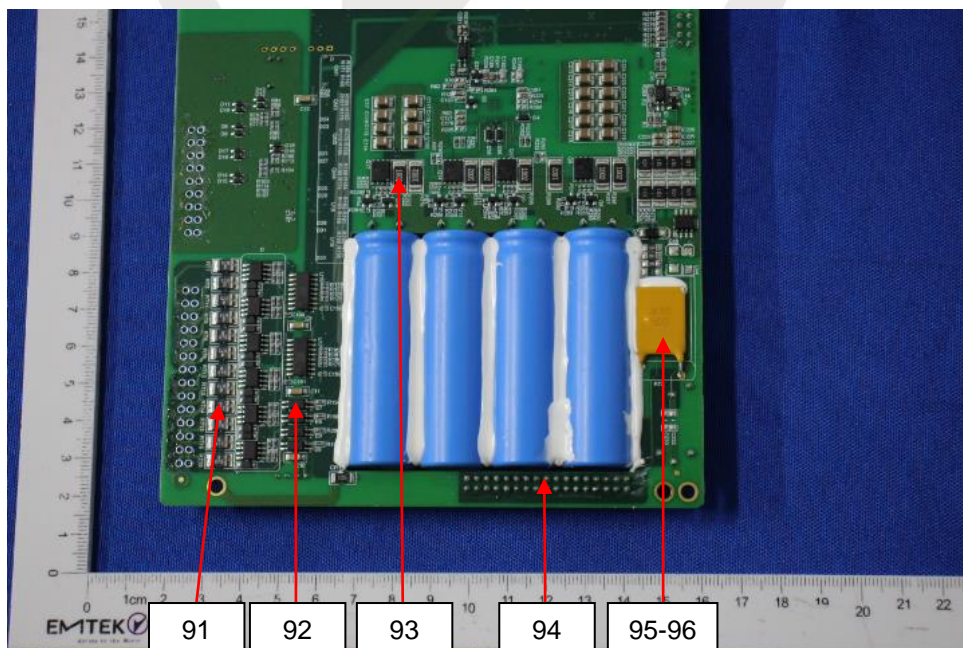
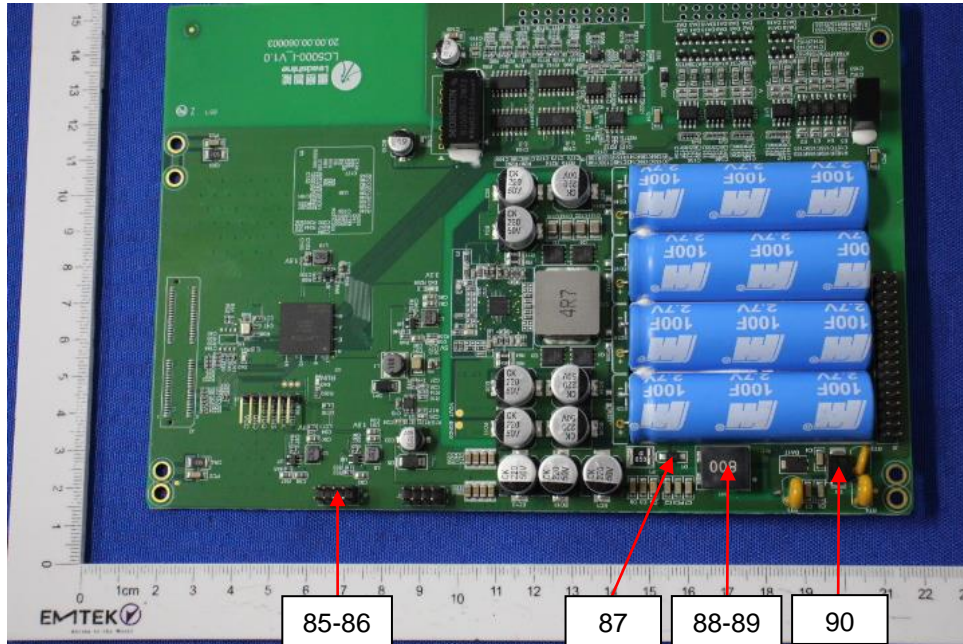

Test results are only responsible for delivered samples. This test report is issued by the company and is intended for your exclusive use. This test report includes all of the testes requested by you and the results thereof based upon the information that you provided. You have 30 days from data of issuance of this test report to notify us of any error or omission caused by our negligence. A failure to raise such issue within the prescribed time shall constitute your unqualified acceptance of the completeness of this report, the tests conducted and the correctness of the report contents.



Test Report

No.: EDG2209210142C00101R

Date: Oct. 08, 2022

Page 79 of 94

Sample Photo

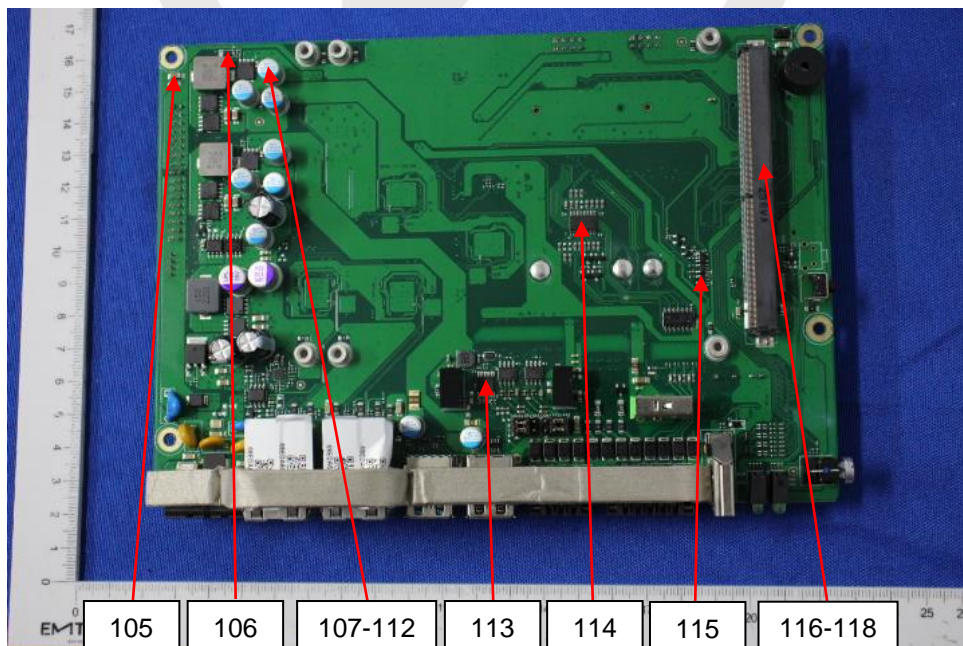
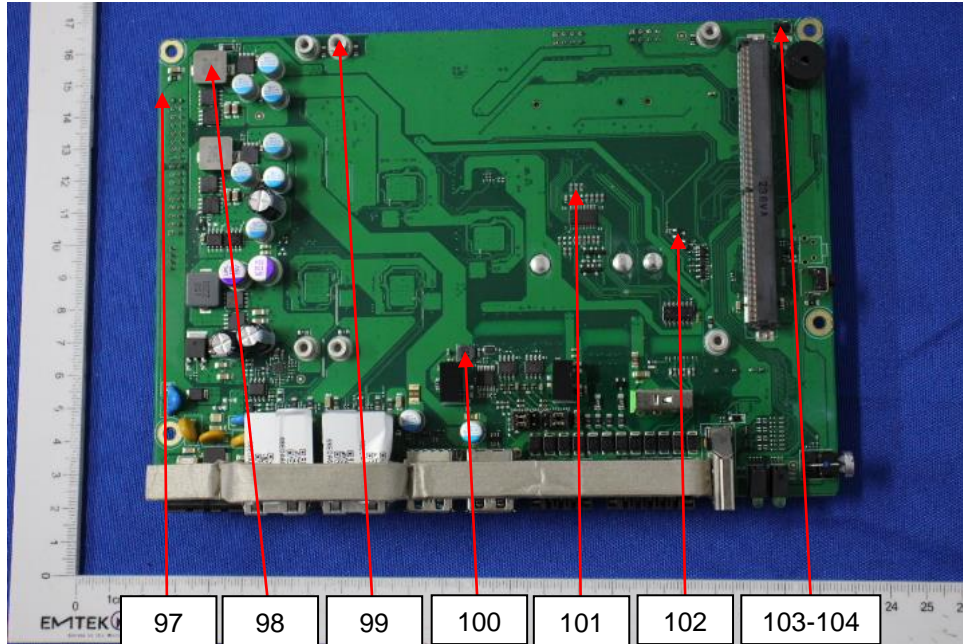

Test results are only responsible for delivered samples. This test report is issued by the company and is intended for your exclusive use. This test report includes all of the testes requested by you and the results thereof based upon the information that you provided. You have 30 days from data of issuance of this test report to notify us of any error or omission caused by our negligence. A failure to raise such issue within the prescribed time shall constitute your unqualified acceptance of the completeness of this report, the tests conducted and the correctness of the report contents.



Test Report

No.: EDG2209210142C00101R

Date: Oct. 08, 2022

Page 80 of 94

Sample Photo

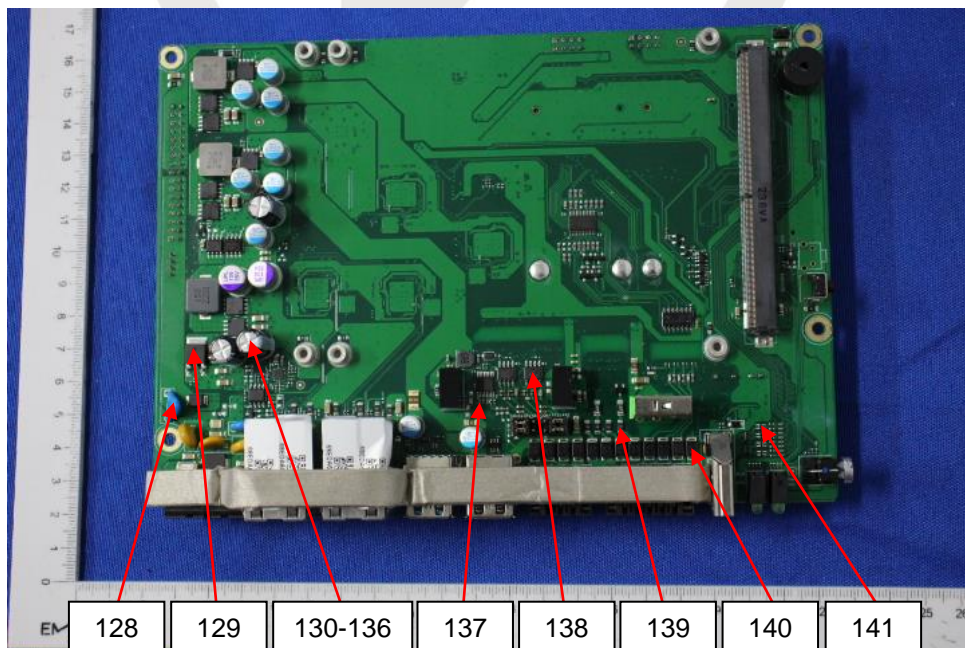
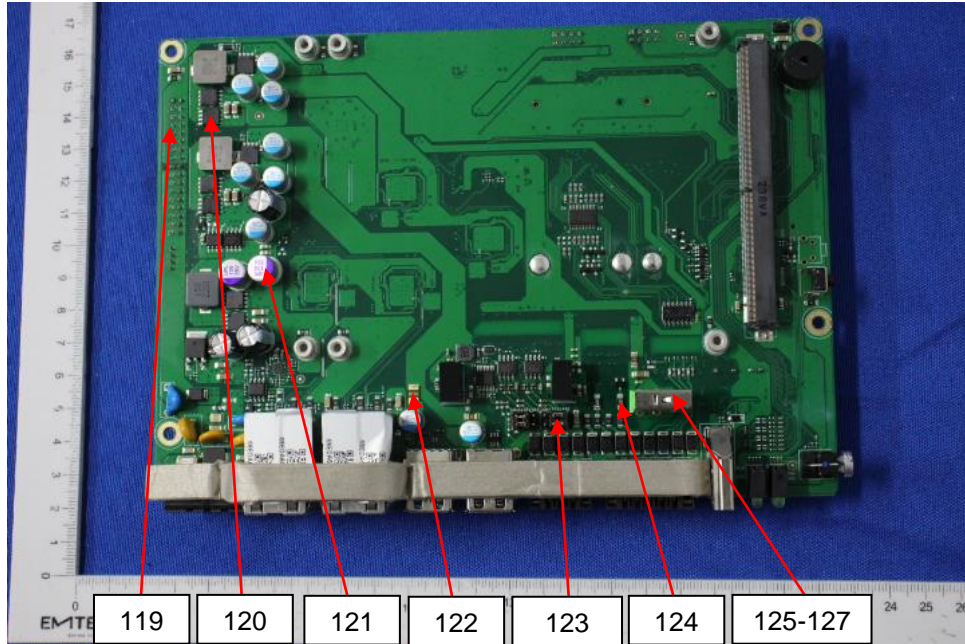

Test results are only responsible for delivered samples. This test report is issued by the company and is intended for your exclusive use. This test report includes all of the testes requested by you and the results thereof based upon the information that you provided. You have 30 days from data of issuance of this test report to notify us of any error or omission caused by our negligence. A failure to raise such issue within the prescribed time shall constitute your unqualified acceptance of the completeness of this report, the tests conducted and the correctness of the report contents.



Test Report

No.: EDG2209210142C00101R

Date: Oct. 08, 2022

Page 81 of 94

Sample Photo

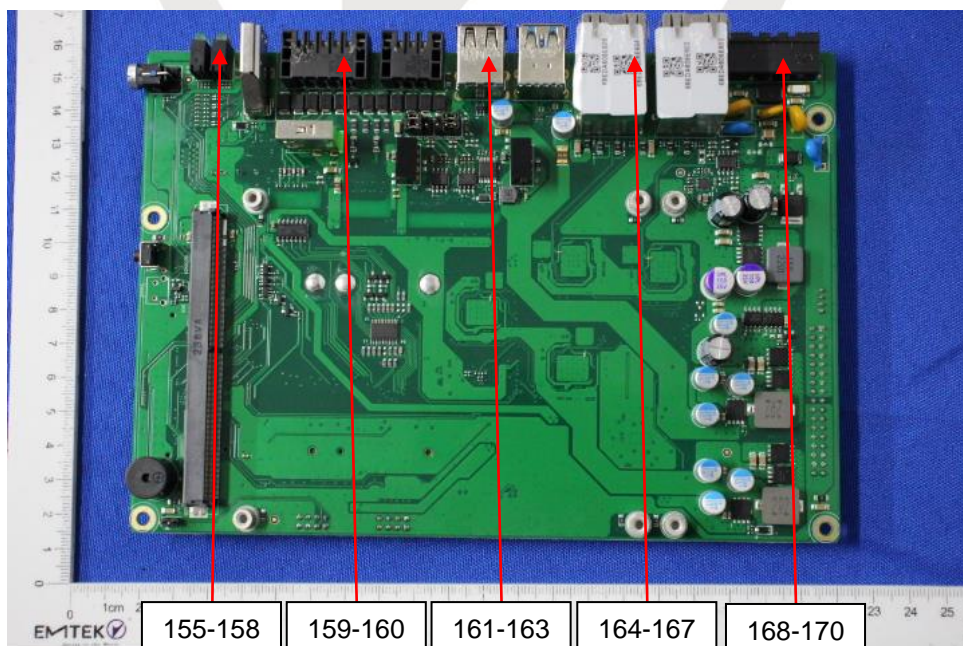
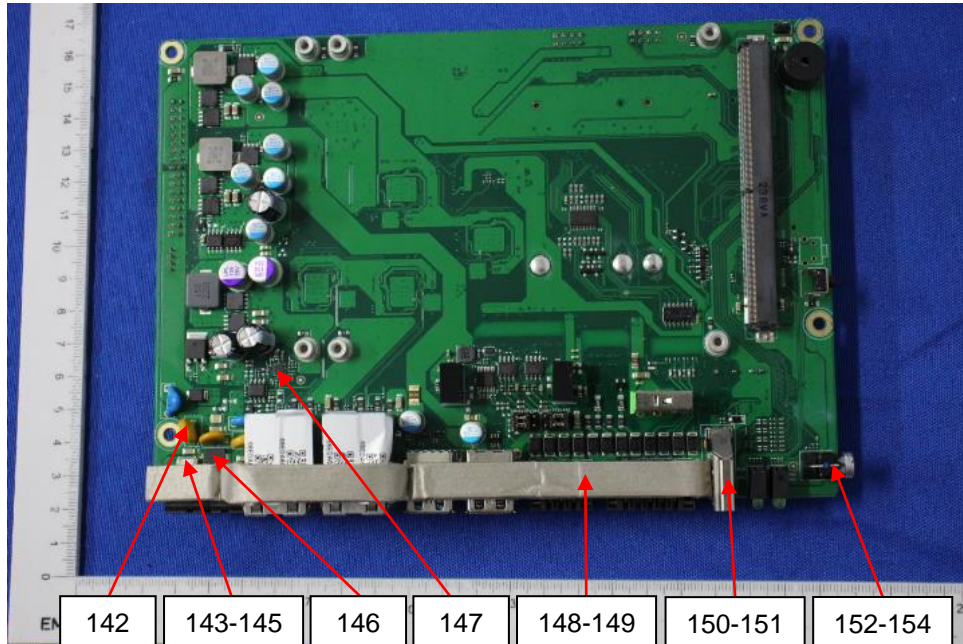

Test results are only responsible for delivered samples. This test report is issued by the company and is intended for your exclusive use. This test report includes all of the testes requested by you and the results thereof based upon the information that you provided. You have 30 days from data of issuance of this test report to notify us of any error or omission caused by our negligence. A failure to raise such issue within the prescribed time shall constitute your unqualified acceptance of the completeness of this report, the tests conducted and the correctness of the report contents.



Test Report

No.: EDG2209210142C00101R

Date: Oct. 08, 2022

Page 82 of 94

Sample Photo

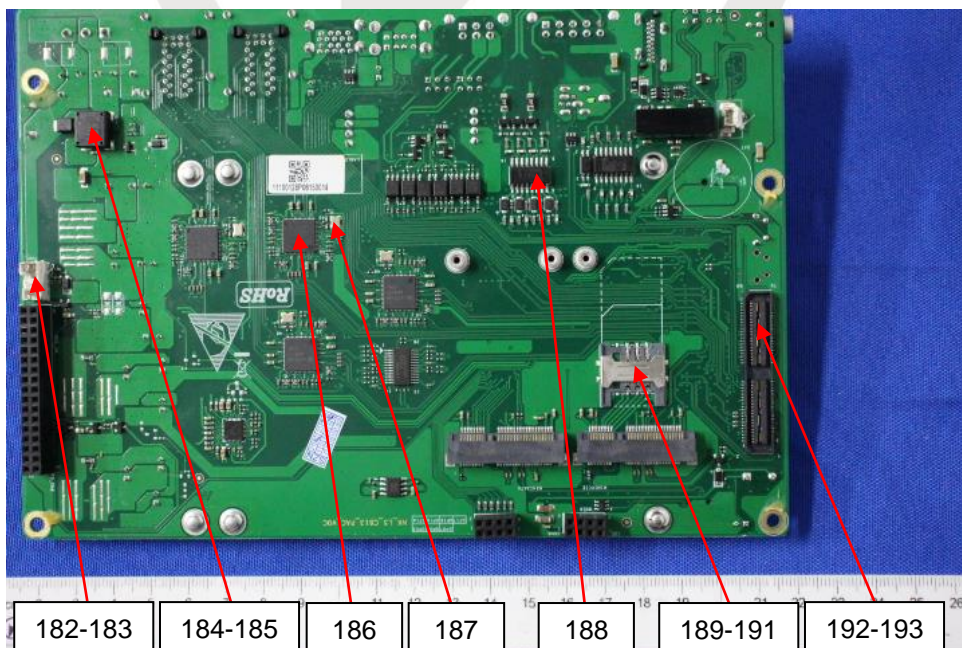
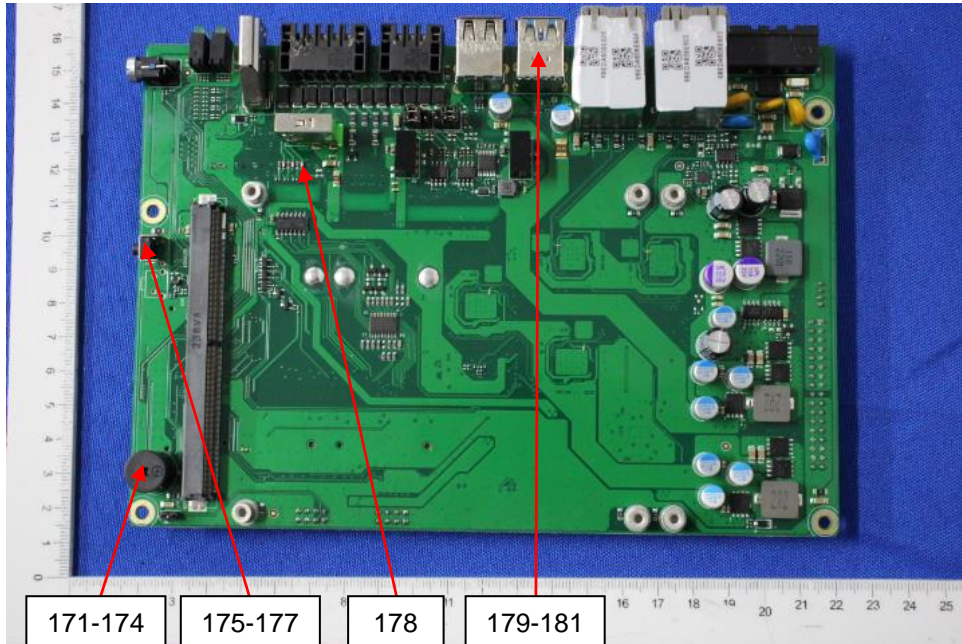

Test results are only responsible for delivered samples. This test report is issued by the company and is intended for your exclusive use. This test report includes all of the testes requested by you and the results thereof based upon the information that you provided. You have 30 days from data of issuance of this test report to notify us of any error or omission caused by our negligence. A failure to raise such issue within the prescribed time shall constitute your unqualified acceptance of the completeness of this report, the tests conducted and the correctness of the report contents.



Test Report

No.: EDG2209210142C00101R

Date: Oct. 08, 2022

Page 83 of 94

Sample Photo

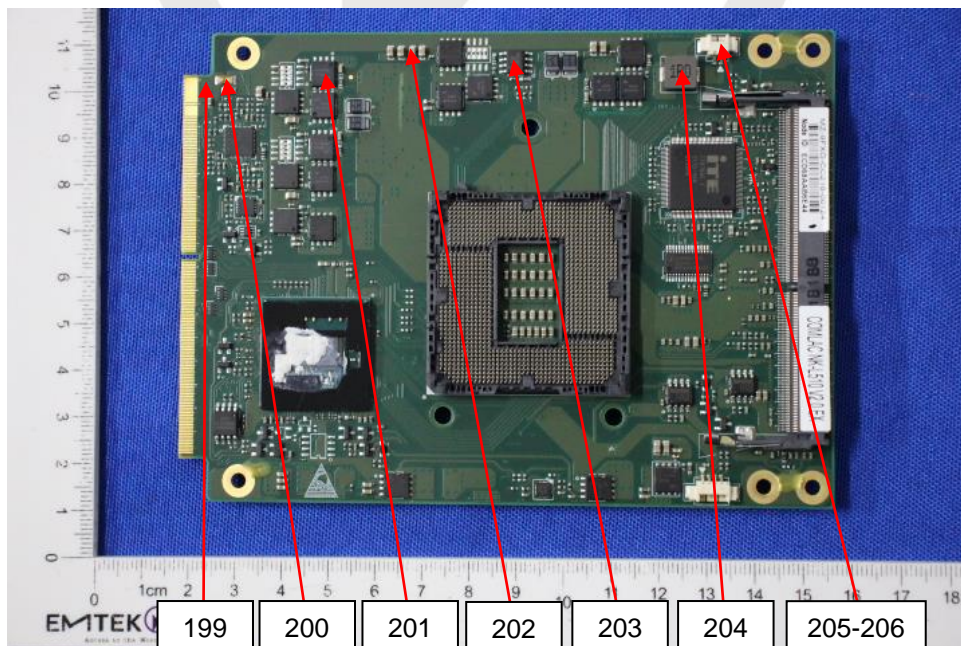
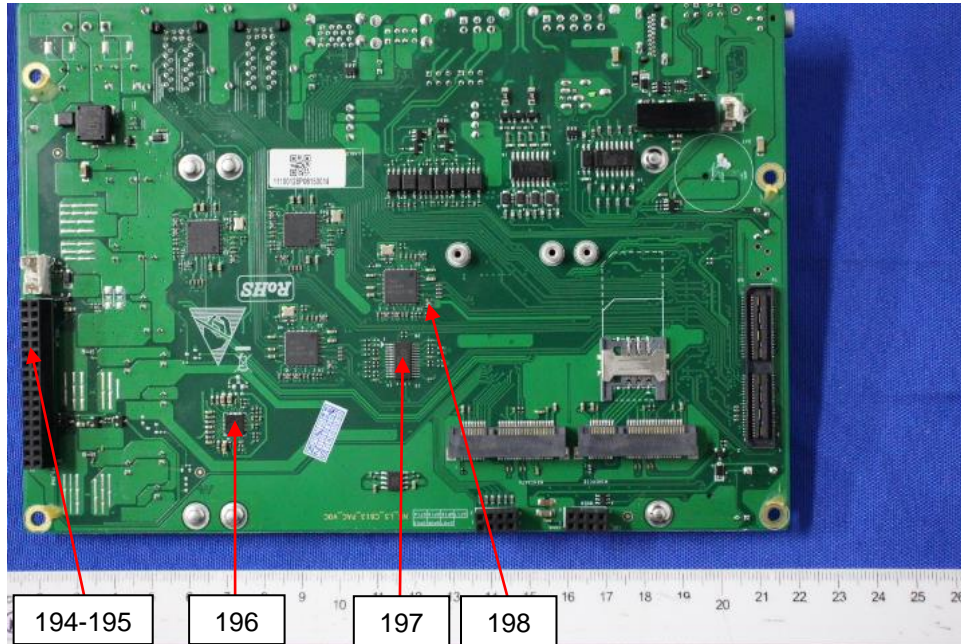

Test results are only responsible for delivered samples. This test report is issued by the company and is intended for your exclusive use. This test report includes all of the testes requested by you and the results thereof based on the information that you provided. You have 30 days from data of issuance of this test report to notify us of any error or omission caused by our negligence. A failure to raise such issue within the prescribed time shall constitute your unqualified acceptance of the completeness of this report, the tests conducted and the correctness of the report contents.



Test Report

No.: EDG2209210142C00101R

Date: Oct. 08, 2022

Page 84 of 94

Sample Photo

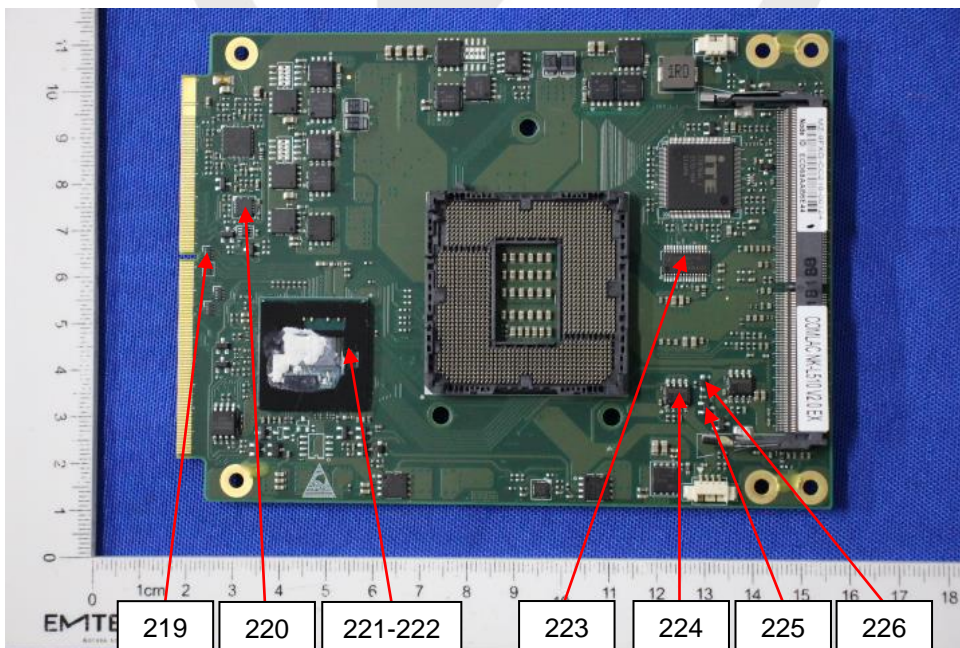
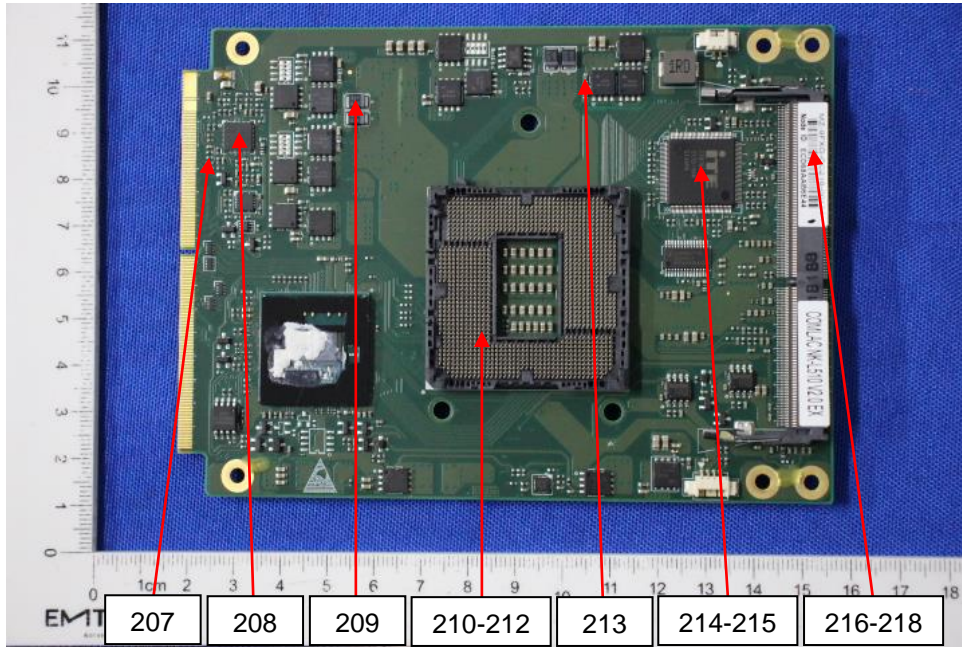

Test results are only responsible for delivered samples. This test report is issued by the company and is intended for your exclusive use. This test report includes all of the testes requested by you and the results thereof based upon the information that you provided. You have 30 days from data of issuance of this test report to notify us of any error or omission caused by our negligence. A failure to raise such issue within the prescribed time shall constitute your unqualified acceptance of the completeness of this report, the tests conducted and the correctness of the report contents.



Test Report

No.: EDG2209210142C00101R

Date: Oct. 08, 2022

Page 85 of 94

Sample Photo

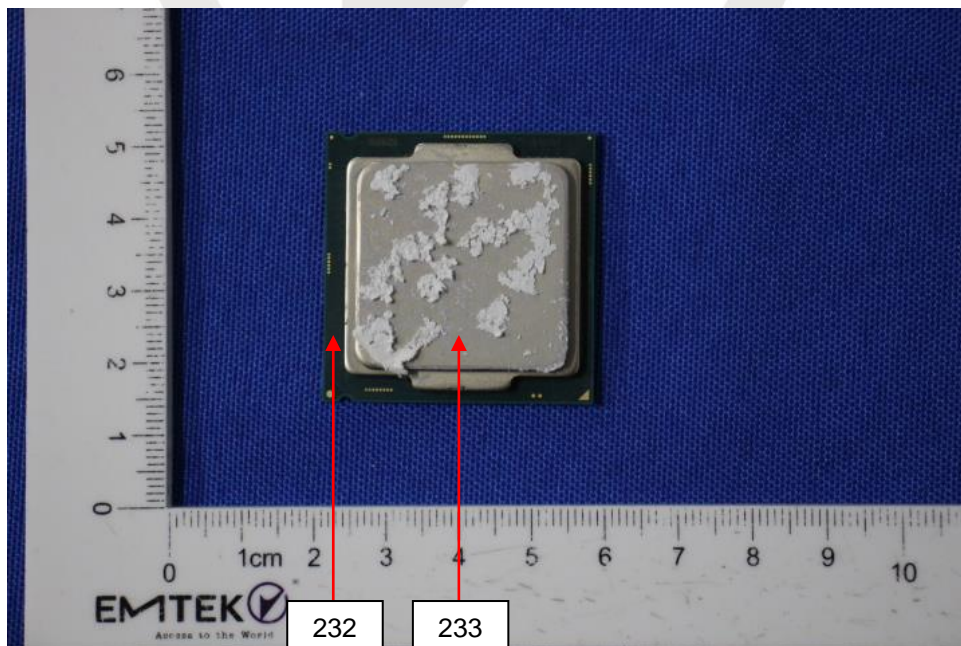
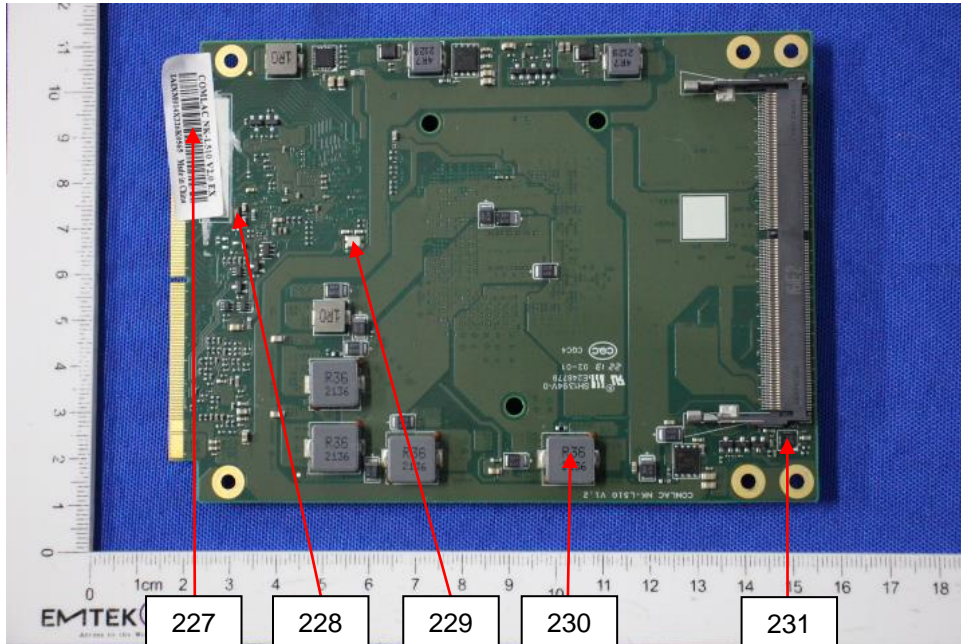

Test results are only responsible for delivered samples. This test report is issued by the company and is intended for your exclusive use. This test report includes all of the testes requested by you and the results thereof based upon the information that you provided. You have 30 days from data of issuance of this test report to notify us of any error or omission caused by our negligence. A failure to raise such issue within the prescribed time shall constitute your unqualified acceptance of the completeness of this report, the tests conducted and the correctness of the report contents.



Test Report

No.: EDG2209210142C00101R

Date: Oct. 08, 2022

Page 86 of 94

Sample Photo

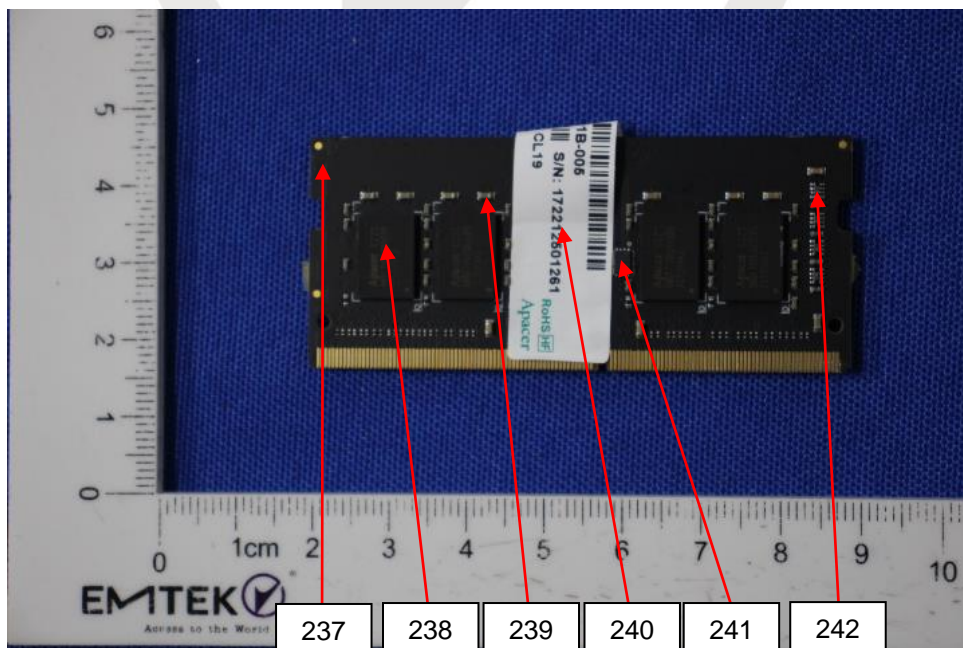
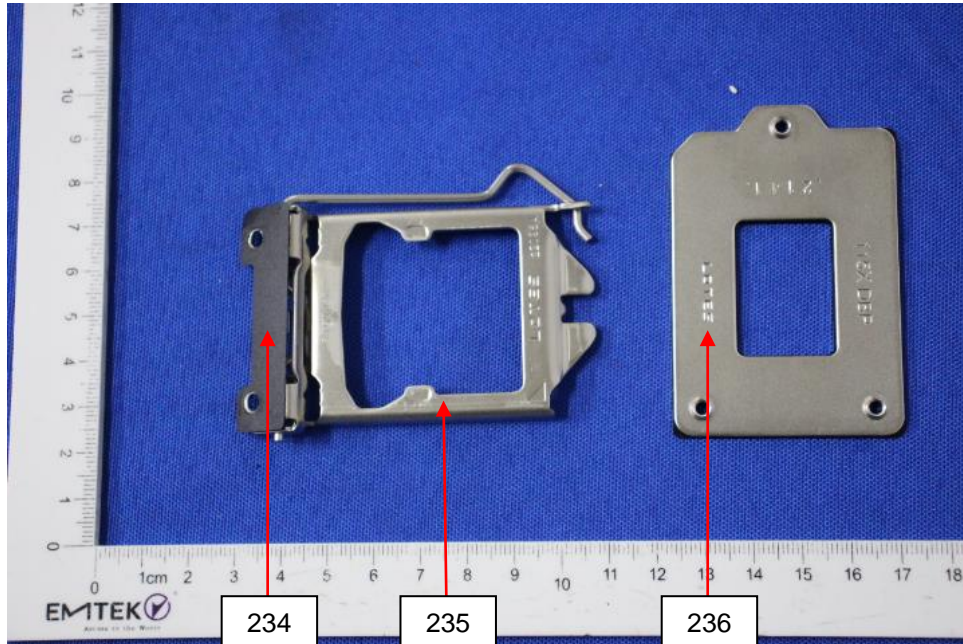

Test results are only responsible for delivered samples. This test report is issued by the company and is intended for your exclusive use. This test report includes all of the testes requested by you and the results thereof based upon the information that you provided. You have 30 days from data of issuance of this test report to notify us of any error or omission caused by our negligence. A failure to raise such issue within the prescribed time shall constitute your unqualified acceptance of the completeness of this report, the tests conducted and the correctness of the report contents.



Test Report

No.: EDG2209210142C00101R

Date: Oct. 08, 2022

Page 87 of 94

Sample Photo

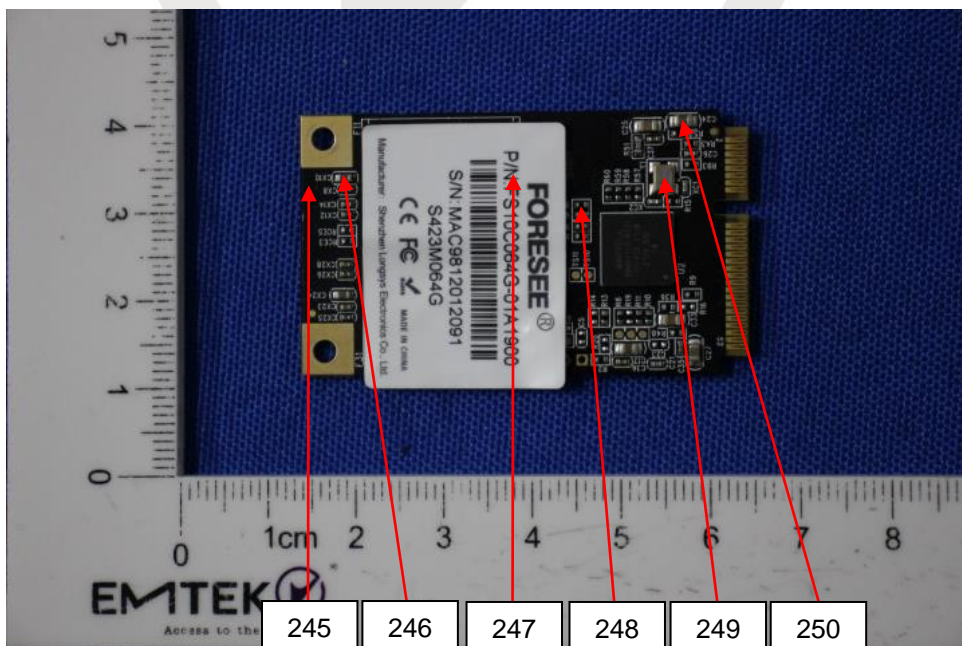
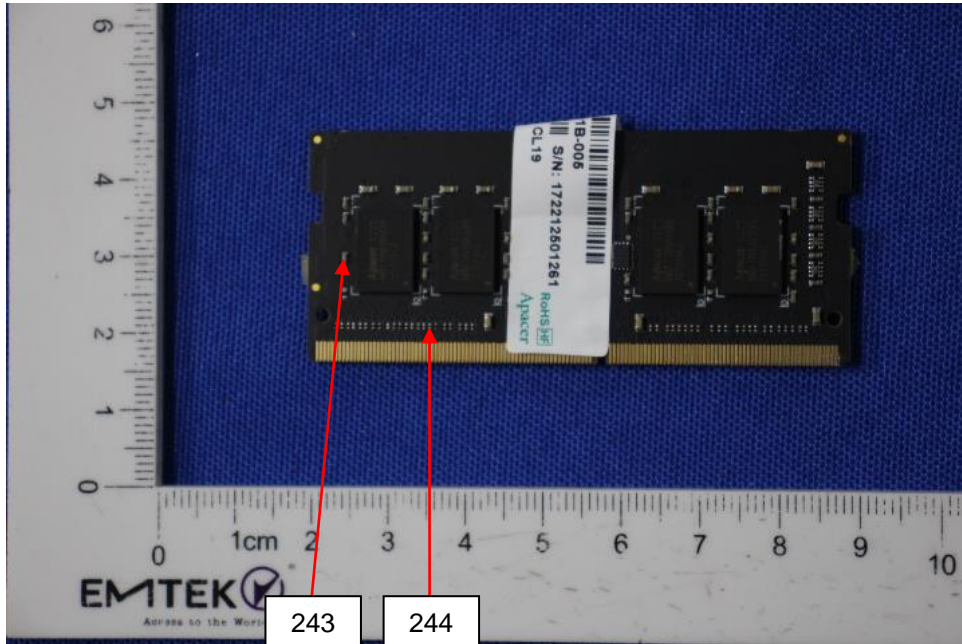

Test results are only responsible for delivered samples. This test report is issued by the company and is intended for your exclusive use. This test report includes all of the testes requested by you and the results thereof based upon the information that you provided. You have 30 days from data of issuance of this test report to notify us of any error or omission caused by our negligence. A failure to raise such issue within the prescribed time shall constitute your unqualified acceptance of the completeness of this report, the tests conducted and the correctness of the report contents.



Test Report

No.: EDG2209210142C00101R

Date: Oct. 08, 2022

Page 88 of 94

Sample Photo

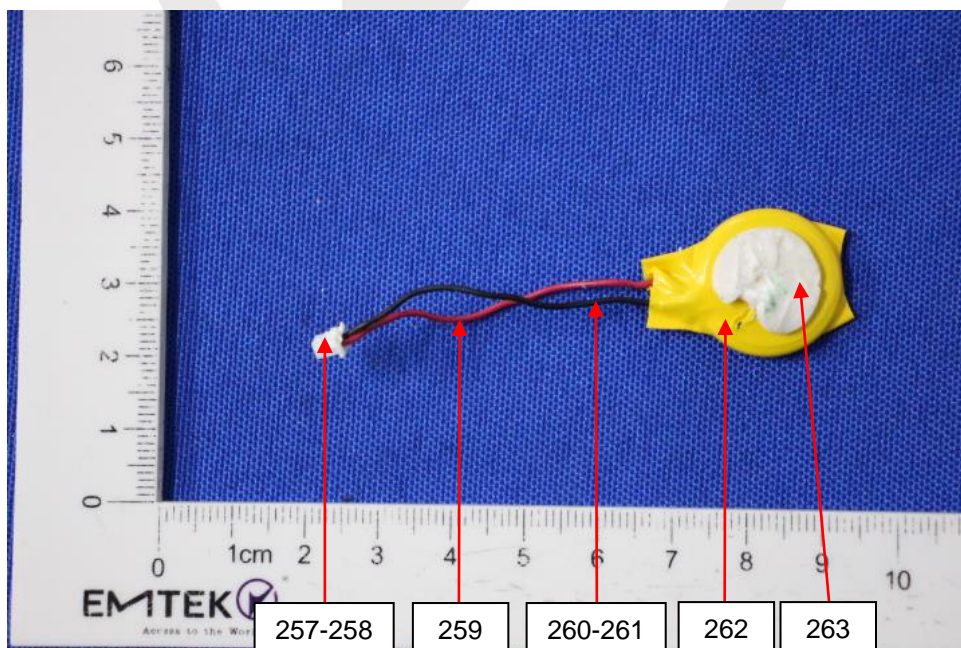
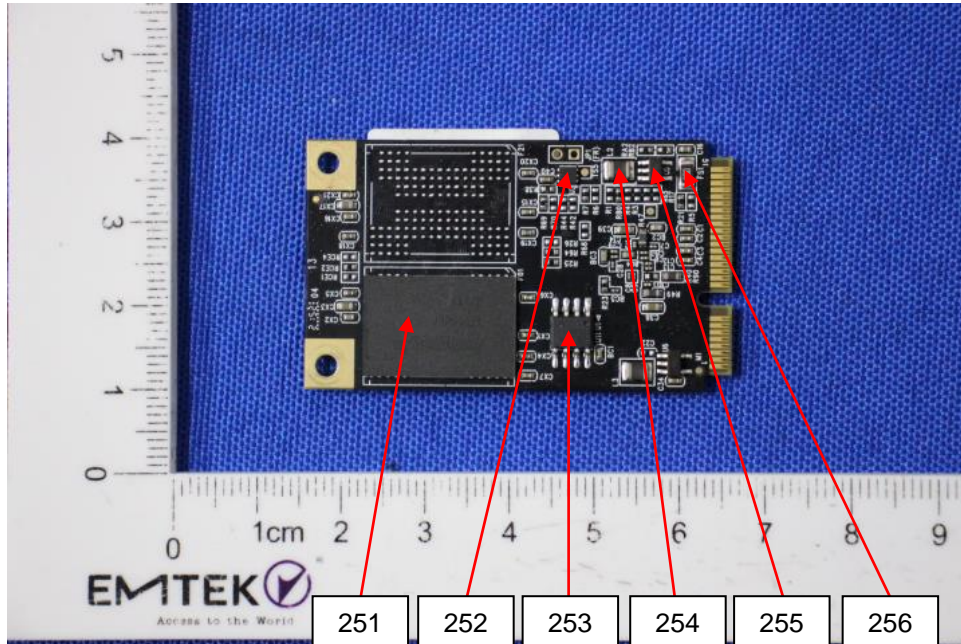

Test results are only responsible for delivered samples. This test report is issued by the company and is intended for your exclusive use. This test report includes all of the testes requested by you and the results thereof based upon the information that you provided. You have 30 days from data of issuance of this test report to notify us of any error or omission caused by our negligence. A failure to raise such issue within the prescribed time shall constitute your unqualified acceptance of the completeness of this report, the tests conducted and the correctness of the report contents.



Test Report

No.: EDG2209210142C00101R

Date: Oct. 08, 2022

Page 89 of 94

Sample Photo

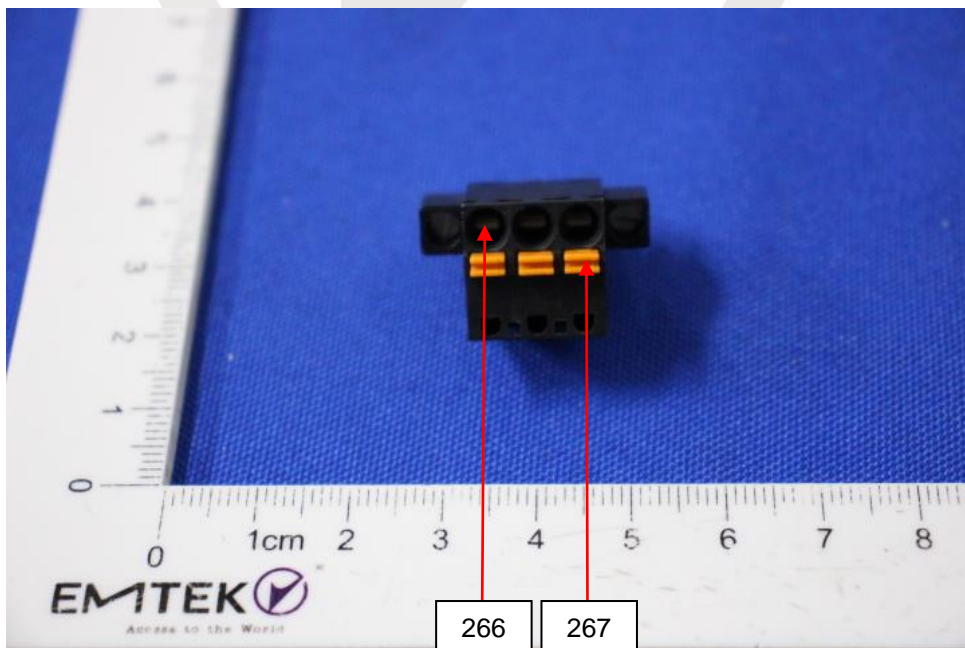
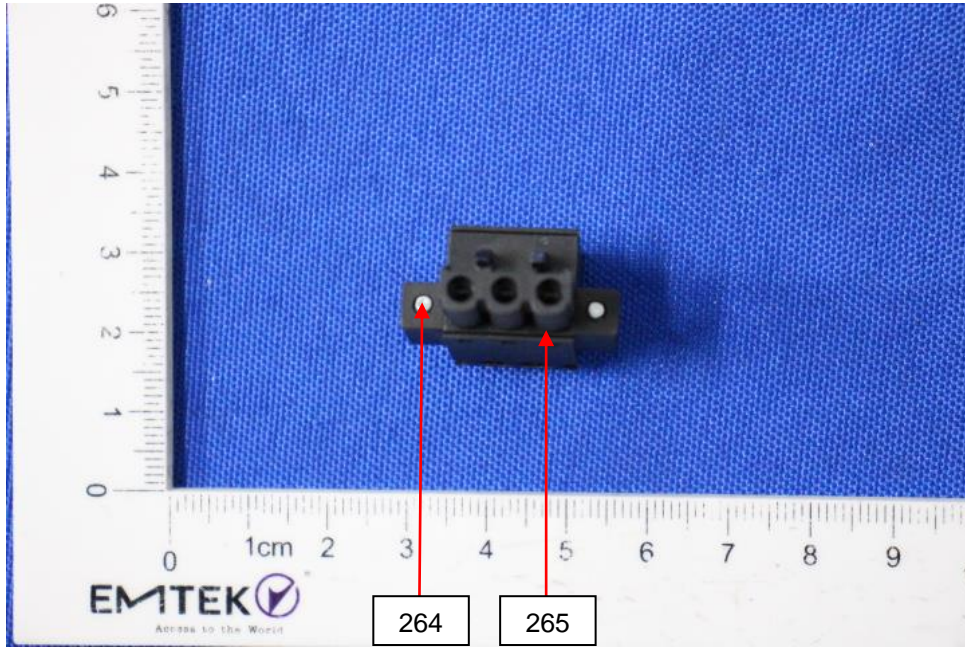

Test results are only responsible for delivered samples. This test report is issued by the company and is intended for your exclusive use. This test report includes all of the testes requested by you and the results thereof based upon the information that you provided. You have 30 days from data of issuance of this test report to notify us of any error or omission caused by our negligence. A failure to raise such issue within the prescribed time shall constitute your unqualified acceptance of the completeness of this report, the tests conducted and the correctness of the report contents.



Test Report

No.: EDG2209210142C00101R

Date: Oct. 08, 2022

Page 90 of 94

Sample Photo



*** End of Report ***

Test results are only responsible for delivered samples. This test report is issued by the company and is intended for your exclusive use. This test report includes all of the testes requested by you and the results thereof based upon the information that you provided. You have 30 days from data of issuance of this test report to notify us of any error or omission caused by our negligence. A failure to raise such issue within the prescribed time shall constitute your unqualified acceptance of the completeness of this report, the tests conducted and the correctness of the report contents.



Test Report

No.: EDG2209210142C00101R

Date: Oct. 08, 2022

Page 91 of 94

ANNEX

EXEMPTION LIST

- 1 Mercury in single capped (compact) fluorescent lamps not exceeding (per burner):
 - 1(a) For general lighting purposes < 30W: 5mg (expires on 31 December 2011; 3.5mg may be used per burner after 31 December 2011 until 31 December 2012; 2.5mg shall be used per burner after 31 December 2012)
 - 1(b) For general lighting purposes \geq 30W and <50W: 5mg (expires on 31 December 2011; 3.5mg may be used per burner after 31 December 2011)
 - 1(c) For general lighting purposes \geq 50W and <150W: 5mg
 - 1(d) For general lighting purposes \geq 150W: 15mg
 - 1(e) For general lighting purposes with circular or square structural shape and tube diameter \leq 17mm (no limitation of use until 31 December 2011; 7mg may be used per burner after 31 December 2011)
 - 1(f) For special purposes: 5mg
 - 1(g) For general lighting purposes < 30 W with a lifetime equal or above 20 000 h: 3,5 mg (Expires on 31 December 2017)
- 2(a) Mercury in double-capped linear fluorescent lamps for general lighting purposes not exceeding (per lamp):
 - 2(a)(1) Tri-band phosphor with normal lifetime and a tube diameter < 9mm (e.g. T2): 5mg (expires on 31 December 2011; 4mg may be used per lamp after 31 December 2011)
 - 2(a)(2) Tri-band phosphor with normal lifetime and a tube diameter \geq 9mm and \leq 17mm (e.g. T5): 5mg (expires on 31 December 2011; 3mg may be used per lamp after 31 December 2011)
 - 2(a)(3) Tri-band phosphor with normal lifetime and a tube diameter > 17mm and \leq 28mm (e.g. T8): 5mg (expires on 31 December 2011; 3.5mg may be used per lamp after 31 December 2011)
 - 2(a)(4) Tri-band phosphor with normal lifetime and a tube diameter > 28mm (e.g. T12): 5mg (expires on 31 December 2012; 3.5mg may be used per lamp after 31 December 2012)
 - 2(a)(5) Tri-band phosphor with long lifetime (\geq 25000h): 8mg (expires on 31 December 2011; 5mg may be used per lamp after 31 December 2011)
- 2(b) Mercury in other fluorescent lamps not exceeding (per lamp):
 - 2(b)(2) Non-linear halophosphate lamps (all diameters): 15mg (expires on 13 April 2016)
 - 2(b)(3) Non-linear tri-band phosphor lamps with tube diameter > 17mm (e.g. T9) (no limitation of use until 31 December 2011; 15mg may be used per lamp after 31 December 2011)
 - 2(b)(4) Lamps for other general lighting and special purposes (e.g. induction lamps) (no limitation of use until 31 December 2011; 15mg may be used per lamp after 31 December 2011)
- 3 Mercury in cold cathode fluorescent lamps and external electrode fluorescent lamps (CCFL and EEFL) for special purposes not exceeding (per lamp):
 - 3(a) Short length (\leq 500mm) (No limitation of use until 31 December 2011; 3.5mg may be used per lamp after 31 December 2011)
 - 3(b) Medium length (> 500mm and \leq 1500mm) (No limitation of use until 31 December 2011; 5mg may be used per lamp after 31 December 2011)
 - 3(c) Long length (> 1500mm) (No limitation of use until 31 December 2011; 13mg may be used per lamp after 31 December 2011)
- 4(a) Mercury in other low pressure discharge lamps (per lamp) (no limitation of use until 31 December 2011; 15mg may be used per lamp after 31 December 2011)
- 4(b) Mercury in High Pressure Sodium (vapour) lamps for general lighting purposes not exceeding (per burner) in lamps with improved colour rendering index $R_a > 60$:
 - 4(b)-I $P \leq 155W$ (no limitation of use until 31 December 2011; 40mg may be used per burner after 31 December 2011)
 - 4(b)-II $155W < P \leq 405W$ (no limitation of use until 31 December 2011; 40mg may be used per burner after 31 December 2011)
 - 4(b)-III $P > 405W$ (no limitation of use until 31 December 2011; 40mg may be used per burner after 31 December 2011)
- 4(c) Mercury in other High Pressure Sodium (vapour) lamps for general lighting purposes not exceeding (per burner):
 - 4(c)-I $P \leq 155W$ (no limitation of use until 31 December 2011; 25mg may be used per burner after 31 December 2011)
 - 4(c)-II $155W < P \leq 405W$ (no limitation of use until 31 December 2011; 30mg may be used per burner after 31 December 2011)
 - 4(c)-III $P > 405W$ (no limitation of use until 31 December 2011; 40mg may be used per burner after 31 December 2011)
- 4(d) Mercury in High Pressure Mercury (vapour) lamps (HPMV) (expires on 13 April 2015)
- 4(e) Mercury in metal halide lamps (MH)
- 4(f) Mercury in other discharge lamps for special purposes not specifically mentioned in this Annex
- 4(g) Mercury in hand crafted luminous discharge tubes used for signs, decorative or architectural and specialist lighting and light-artwork, where the mercury content shall be limited as follows: (Expires on 31 December 2018)
 - (a) 20 mg per electrode pair + 0,3 mg per tube length in cm, but not more than 80 mg, for outdoor applications and indoor applications exposed to temperatures below 20 °C;
 - (b) 15 mg per electrode pair + 0,24 mg per tube length in cm, but not more than 80 mg, for all other indoor applications.

Test results are only responsible for delivered samples. This test report is issued by the company and is intended for your exclusive use. This test report includes all of the testes requested by you and the results thereof based upon the information that you provided. You have 30 days from data of issuance of this test report to notify us of any error or omission caused by our negligence. A failure to raise such issue within the prescribed time shall constitute your unqualified acceptance of the completeness of this report, the tests conducted and the correctness of the report contents.



Test Report

No.: EDG2209210142C00101R

Date: Oct. 08, 2022

Page 92 of 94

ANNEX

EXEMPTION LIST

Continued

- 5(a) Lead in glass of cathode ray tubes
- 5(b) Lead in glass of fluorescent tubes not exceeding 0.2% by weight
- 6(a) Lead as an alloying element in steel for machining purposes and in galvanized steel containing up to 0.35% lead by weight
- 6(b) Lead as an alloying element in aluminium containing up to 0.4% lead by weight
- 6(c) Copper alloy containing up to 4% lead by weight.
- 7(a) Lead in high melting temperature type solders (i.e. lead based alloys containing 85% by weight or more lead)
- 7(b) Lead in solders for servers, storage and storage array systems, network infrastructure equipment for switching, signalling, transmission, and network management for telecommunications
- 7(c)-I Electrical and electronic components containing lead in a glass or ceramic other than dielectric ceramic in capacitors, e.g. piezoelectric devices, or in a glass or ceramic matrix compound
- 7(c)-II Lead in dielectric ceramic in capacitors for a rated voltage of 125V AC or 250V DC or higher
- 7(c)-III Lead in dielectric ceramic in capacitors for a rated voltage of less than 125V AC or 250V DC (expires on 1 January 2013 and after that date may be used in spare parts for EEE placed on the market before 1 January 2013).
- 7(c)-IV Lead in PZT based dielectric ceramic materials for capacitors being part of integrated circuits or discrete semiconductors
- 8(a) Cadmium and its compounds in one shot pellet type thermal cut-offs (expires on 1 January 2012 and after that date may be used in spare parts for EEE placed on the market before 1 January 2012)
- 8(b) Cadmium and its compounds in electrical contacts
Applies to categories 8, 9 and 11 and expires on:
— 21 July 2021 for categories 8 and 9 other than in vitro diagnostic medical devices and industrial monitoring and control instruments;
— 21 July 2023 for category 8 in vitro diagnostic medical devices;
— 21 July 2024 for category 9 industrial monitoring and control instruments, and for category 11
- 8(b)-I Cadmium and its compounds in electrical contacts used in:
Applies to categories 1 to 7 and 10 and expires on 21 July 2021.
— circuit breakers,
— thermal sensing controls,
— thermal motor protectors (excluding hermetic thermal motor protectors),
— AC switches rated at:— 6 A and more at 250 V AC and more, or
— 12 A and more at 125 V AC and more,
— DC switches rated at 20 A and more at 18 V DC and more, and
— switches for use at voltage supply frequency \geq 200 Hz.
- 9 Hexavalent chromium as an anti-corrosion agent of the carbon steel cooling system in absorption refrigerators up to 0.75% by weight in the cooling solution
- 9(b) Lead in bearing shells and bushes for refrigerant-containing compressors for heating, ventilation, air conditioning and refrigeration (HVACR) applications
- 11(b) Lead used in other than C-press compliant pin connector systems (expires on 1 January 2013 and after that date may be used in spare parts for EEE placed on the market before 1 January 2013)
- 13(a) Lead in white glasses used for optical applications
- 13(b) Cadmium and lead in filter glasses and glasses used for reflectance standards
- 14 Lead in solders consisting of more than two elements for the connection between the pins and the package of microprocessors with a lead content of more than 80% and less than 85% by weight (expires on 1 January 2011 and after that date may be used in spare parts for EEE placed on the market before 1 January 2011)
- 15 Lead in solders to complete a viable electrical connection between semiconductor die and carrier within integrated circuit Flip Chip packages
- 17 Lead halide as radiant agent in High Intensity Discharge (HID) lamps used for professional reprography applications
- 18(b) Lead as activator in the fluorescent powder (1% lead by weight or less) of discharge lamps when used as sun tanning lamps containing phosphors such as BSP ($BaSi_2O_5:Pb$)
- 21 Lead and cadmium in printing inks for the application of enamels on glasses, such as borosilicate and soda lime glass
- 24 Lead in solders for the soldering to machined through hole discoidal and planar array ceramic multilayer capacitors
- 25 Lead oxide in surface conduction electron emitter displays (SED) used in structural elements, notably in the seal frit and frit ring
- 29 Lead bound in crystal glass as defined in Annex 1 (Categories 1, 2, 3 and 4) of Council Directive 69/493/EEC
- 30 Cadmium alloys as electrical/mechanical solder joints to electrical conductors located directly on the voice coil in transducers used in high-powered loudspeakers with sound pressure levels of 100 dB (A) and more

Test results are only responsible for delivered samples. This test report is issued by the company and is intended for your exclusive use. This test report includes all of the testes requested by you and the results thereof based upon the information that you provided. You have 30 days from data of issuance of this test report to notify us of any error or omission caused by our negligence. A failure to raise such issue within the prescribed time shall constitute your unqualified acceptance of the completeness of this report, the tests conducted and the correctness of the report contents.



Test Report

No.: EDG2209210142C00101R

Date: Oct. 08, 2022

Page 93 of 94

ANNEX

EXEMPTION LIST

Continued

- 31 Lead in soldering materials in mercury free flat fluorescent lamps (which e.g. are used for liquid crystal displays, design or industrial lighting)
- 32 Lead oxide in seal frit used for making window assemblies for Argon and Krypton laser tubes
- 33 Lead in solders for the soldering of thin copper wires of 100 µm diameter and less in power transformers
- 34 Lead in cermet-based trimmer potentiometer elements
- 37 Lead in the plating layer of high voltage diodes on the basis of a zinc borate glass body
- 38 Cadmium and cadmium oxide in thick film pastes used on aluminium bonded beryllium oxide
- 39 Cadmium in colour converting II-VI LEDs (< 10 µg Cd per mm² of light-emitting area) for use in solid state illumination or display systems (expires on 1 July 2014)
- 41 Lead in solders and termination finishes of electrical and electronic components and finishes of printed circuit boards used in ignition modules and other electrical and electronic engine control systems, which for technical reasons must be mounted directly on or in the crankcase or cylinder of hand-held combustion engines (classes SH:1, SH:2, SH:3 of Directive 97/68/EC of the European Parliament and of the Council (2)) (Expires on 31 December 2018)
- 43 Bis(2-ethylhexyl) phthalate in rubber components in engine systems, designed for use in equipment that is not intended solely for consumer use and provided that no plasticised material comes into contact with human mucous membranes or into prolonged contact with human skin and concentration value of bis(2-ethylhexyl) phthalate does not exceed:
- a) 30% by weight of the rubber for
 - (i) gasket coatings;
 - (ii) solid-rubber gaskets; or
 - (iii) rubber components included in assemblies of at least three components using electrical, mechanical or hydraulic energy to do work, and attached to the engine.
 - b) 10% by weight of the rubber for rubber-containing components not referred to in point (a).
- For the purposes of this entry, "prolonged contact with human skin" means continuous contact of more than 10 minutes duration or intermittent contact over a period of 30 minutes, per day.
- 44 Lead in solder of sensors, actuators, and engine control units of combustion engines within the scope of Regulation (EU) 2016/1628 of the European Parliament and of the Council, installed in equipment used at fixed positions while in operation which is designed for professionals, but also used by non-professional users.

Test results are only responsible for delivered samples. This test report is issued by the company and is intended for your exclusive use. This test report includes all of the testes requested by you and the results thereof based upon the information that you provided. You have 30 days from data of issuance of this test report to notify us of any error or omission caused by our negligence. A failure to raise such issue within the prescribed time shall constitute your unqualified acceptance of the completeness of this report, the tests conducted and the correctness of the report contents.



Test Report

No.: EDG2209210142C00101R

Date: Oct. 08, 2022

Page 94 of 94

声明 Statement

- 1.本检测报告首页所列信息中除样品来源、接样日期、检测日期、检测结果和检测结论外，均由委托方提供，委托方对样品的代表性和资料的真实性负责，本实验室不承担任何相关责任。
The information as listed on the first page of this test report was all provided by the client except the sample from, date received, test period, test results and test conclusion. The client shall be responsible for the representativeness of sample and authenticity of materials, for which EMTEK shall bear no responsibilities.
- 2.本检测报告以实测值进行符合性判定，未考虑不确定度所带来的风险，特别约定、标准或规范中有明确规定的除外。此种判定方式所带来的风险由客户自行承担，本实验室不承担相关责任。
The judgment method of determining the conformity in this test report is according to the measured value without considering the risk caused by uncertainty, unless otherwise clearly stipulated in special agreement, standard or specification. The client shall assume the risk caused by the judgment method, and EMTEK shall not bear related responsibilities.
- 3.检测报告无批准人签字及“检验检测专用章”无效，未经本实验室书面同意，不得整体或部分复制本报告。
The test report is effective only with both signature and specialized stamp. Without written approval of EMTEK, this report can't be reproduced in full or in part.
- 4.本检测报告的检测结果仅对送测样品负责，未加盖资质认定标志的检测报告不对社会具有公证证明作用，对于检测数据、结果的使用，所产生的直接或间接损失及一切法律后果，本实验室不承担任何经济和法律后果。
This test data is only responsible for the tested sample. The data and results provided by the report without CMA accreditation are not to prove to the society, and EMTEK is not responsible for any economic and legal responsibility for the use of the test data, the direct or indirect losses resulting from the use of the test and all legal consequences.
- 5.本检测报告中检测项目标注有特殊符号则该项目不在本实验室资质认定能力范围内，该项目检测结果仅作为客户委托、科研、教学或内部质量控制等目的使用。
The test items are marked with special symbols in the report is out of the scope of CMA accreditation. The test result only used for client's requirement, scientific researching ,teaching or internal quality control.
- 6.其它声明请查阅报告页脚及书面报告末页。
For other statements, please refer to the footer of the report.

Test results are only responsible for delivered samples. This test report is issued by the company and is intended for your exclusive use. This test report includes all of the testes requested by you and the results thereof based upon the information that you provided. You have 30 days from data of issuance of this test report to notify us of any error or omission caused by our negligence. A failure to raise such issue within the prescribed time shall constitute your unqualified acceptance of the completeness of this report, the tests conducted and the correctness of the report contents.



签发测试报告条款 Conditions of Issuance of Test Reports

1. 东莞市信测科技有限公司（以下简称[本公司]）为提供符合下述条款的测试和报告，而接受有关样品和货品。本公司基于下述条款提供服务，下述条款为本公司与申请服务的个人，企业或公司（以下简称[客户]）的协议。
All samples and goods are accepted by the EMTEK(Dongguan) Co., Ltd. (the "Company") solely for testing and reporting in accordance with the following terms and conditions. The company provides its services on the basis that such terms and conditions constitute express agreement between the Company and any person, firm or company requesting its services (the "Clients").
2. 由此测试申请所发出的任何报告（以下简称[报告]），本公司会严格为客户保密。未经本公司的书面同意，报告的整体或部分不得复制，也不得用于广告或授权的其他用途。然而，客户可以将本公司印制的报告或认可的副本，向其客户、供货商或直接相关的其他人出示或提交。除非相关政府部门、法律或法规要求，否则未经客户同意，本公司不得将报告内容向任何第三方讨论或披露。
Any report issued by Company as a result of this application for testing services (the "Report") shall be issued in confidence to the Clients and the Report will be strictly treated as such by the Company. It may not be reproduced either in its entirety or in part and it may not be used for advertising or other unauthorized purposes without the written consent of the Company. The Clients to whom the Report is issued may, however, show or send it, or a certified copy thereof prepared by the Company to its customer, supplier or other persons directly concerned. The Company will not, without the consent of the Clients, enter into any discussion or correspondence with any third party concerning the contents of the Report, unless required by the relevant governmental authorities, laws or court orders.
3. 除非相关政府部门、法律或法院要求，否则未经公司预先书面同意，本公司毋庸，也并无义务到法院对有关报告作证。
The Company shall not be called or be liable to be called to give evidence or testimony on the Report in a court of law without its prior written consent, unless required by the relevant governmental authorities, laws or court orders.
4. 如果本公司确定报告被不当地使用，本公司保留撤回报告的权利，并有权要求其它适当的额外赔偿。
In the event of the improper use of the report as determined by the Company, the Company reserves the right to withdraw it, and to adopt any other additional remedies which may be appropriate.
5. 本公司接受样品进行测试的前提是，该测试报告不能作为针对本公司法律行动的依据。
Samples submitted for testing are accepted on the understanding that the Report issued cannot form the basis of, or be the instrument for, any legal action against the Company.
6. 如因使用本公司中心任何报告内的资料，或任何传播信息所描述与之有关的测试或研究导致的任何损失或损害，本公司概不负责。
The Company will not be liable for or accept responsibility for any loss or damage however arising from the use of information contained in any of its Reports or in any communication whatsoever about its said tests or investigations.
7. 若需要在法院审理程序或者仲裁过程中使用测试报告，客户必须在提交测试样品前将该意图告知本公司。
Clients wishing to use the Report in court proceedings or arbitration shall inform the Company to that effect prior to submitting the sample for testing.
8. 该测试报告的支持数据和信息本公司保存 10 年。个别评审机构有特别要求的，检测数据和报告的保存期可依情况变动。一旦超过上述提交的保存期限，数据和信息将被处理掉。任何情况下，本公司不必提供任何被处理的过期数据或信息。即使本公司事先被告知可能会发生相关的损害，本公司在任何情况下也不必承担任何损害，包括（但不限于）补偿性赔偿、利润损失、数据遗失、或任何形式的特殊损害、附带损害、间接损害、从属损害或任何违反约定、违反承诺、侵权（包括疏忽）、产品责任或其他原因的惩罚性损害。
Subject to the variable length of retention time for test data and report stored hereinto as otherwise specifically required by individual accreditation authorities, the Company will only keep the supporting test data and information of the test report for a period of ten years. The data and information will be disposed of after the aforementioned retention period has elapsed. Under no circumstances shall we provide any data and information which has been disposed of after retention period. Under no circumstances shall we be liable for damage of any kind, including (but not limited to) compensatory damages, lost profits, lost data, or any form of special, incidental, indirect, consequential or punitive damages of any kind, whether based on breach of contract of warranty, tort (including negligence), product liability or otherwise, even if we are informed in advance of the possibility of such damages.

